

DATASHEET

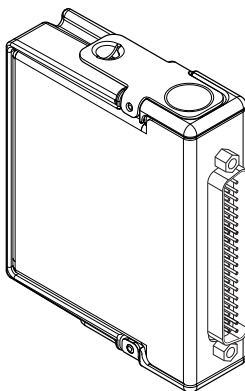

NI 9216

8 RTD, 0 Ω to 400 Ω , 24 Bit, 400 S/s Aggregate, PT100

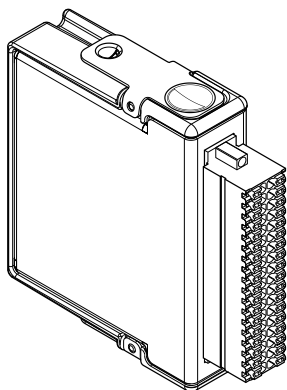

- DSUB or push-in spring-terminal connectivity
- 250 Vrms, CAT II, channel-to-earth isolation (spring terminal); 60 VDC, CAT I, channel-to-earth isolation (DSUB)
- 50 Hz/60 Hz noise rejection

The NI 9216 RTD analog input C Series module features eight channels and 24 bits of resolution for PT100 RTD measurements. The NI 9216, compatible with 3- and 4-wire RTD measurements, automatically detects the type of RTD (3- or 4-wire) connected to the channel and configures each channel for the appropriate mode. The module provides 1 mA of current excitation per channel and has less than a ± 1.0 $^{\circ}\text{C}$ accuracy error over its entire operating temperature range. NI provides calibration services for the NI 9216.

	Kit Contents <ul style="list-style-type: none">• NI 9216• NI 9216 Getting Started Guide
	Accessories <ul style="list-style-type: none">• NI 9974 Spring-Terminal Block• NI 9940 Backshell Connector Kit

NI C Series Overview



NI provides more than 100 C Series modules for measurement, control, and communication applications. C Series modules can connect to any sensor or bus and allow for high-accuracy measurements that meet the demands of advanced data acquisition and control applications.

- Measurement-specific signal conditioning that connects to an array of sensors and signals
- Isolation options such as bank-to-bank, channel-to-channel, and channel-to-earth ground
- -40 °C to 70 °C temperature range to meet a variety of application and environmental needs
- Hot-swappable

The majority of C Series modules are supported in both CompactRIO and CompactDAQ platforms and you can move modules from one platform to the other with no modification.

CompactRIO



CompactRIO combines an open-embedded architecture with small size, extreme ruggedness, and C Series modules in a platform powered by the NI LabVIEW reconfigurable I/O (RIO) architecture. Each system contains an FPGA for custom timing, triggering, and processing with a wide array of available modular I/O to meet any embedded application requirement.

CompactDAQ

CompactDAQ is a portable, rugged data acquisition platform that integrates connectivity, data acquisition, and signal conditioning into modular I/O for directly interfacing to any sensor or signal. Using CompactDAQ with LabVIEW, you can easily customize how you acquire, analyze, visualize, and manage your measurement data.



Software

LabVIEW Professional Development System for Windows



- Use advanced software tools for large project development
- Generate code automatically using DAQ Assistant and Instrument I/O Assistant
- Use advanced measurement analysis and digital signal processing
- Take advantage of open connectivity with DLLs, ActiveX, and .NET objects
- Build DLLs, executables, and MSI installers

NI LabVIEW FPGA Module

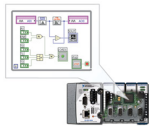

- Design FPGA applications for NI RIO hardware
- Program with the same graphical environment used for desktop and real-time applications
- Execute control algorithms with loop rates up to 300 MHz
- Implement custom timing and triggering logic, digital protocols, and DSP algorithms
- Incorporate existing HDL code and third-party IP including Xilinx IP generator functions
- Purchase as part of the LabVIEW Embedded Control and Monitoring Suite

NI LabVIEW Real-Time Module

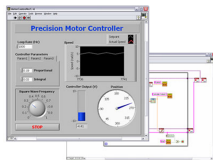

- Design deterministic real-time applications with LabVIEW graphical programming
- Download to dedicated NI or third-party hardware for reliable execution and a wide selection of I/O
- Take advantage of built-in PID control, signal processing, and analysis functions
- Automatically take advantage of multicore CPUs or set processor affinity manually
- Take advantage of real-time OS, development and debugging support, and board support
- Purchase individually or as part of a LabVIEW suite

Input Circuitry

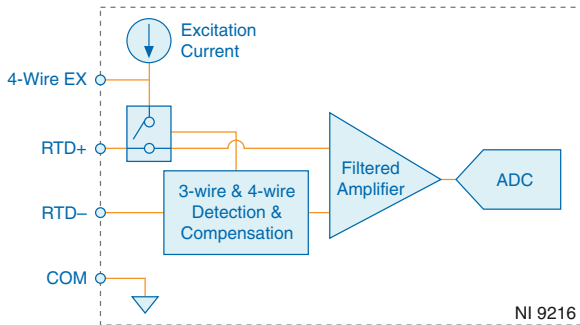

- RTD channels share a common ground that is isolated from other modules in the system.
- Each RTD channel is filtered and then sampled by a 24-bit analog-to-digital converter (ADC).

NI 9216 Specifications

The following specifications are typical for the range $-40\text{ }^{\circ}\text{C}$ to $70\text{ }^{\circ}\text{C}$ unless otherwise noted.



Caution Do not operate the NI 9216 in a manner not specified in this document. Product misuse can result in a hazard. You can compromise the safety protection built into the product if the product is damaged in any way. If the product is damaged, return it to NI for repair.

Input Characteristics

Number of channels	8 analog input channels
ADC resolution	24 bits
Type of ADC	Delta-sigma
Sampling mode	Scanned
Measurement range	
Temperature	$-200\text{ }^{\circ}\text{C}$ to $850\text{ }^{\circ}\text{C}$
Resistance	$0\ \Omega$ to $400\ \Omega$
Conversion time	
High-resolution mode	200 ms per channel, 1600 ms total for all channels
High-speed mode	2.5 ms per channel, 20 ms total for all channels

Table 1. Temperature Accuracy (including noise)¹, 4-wire mode

Measured Value	Typical (25 °C)	Maximum (-40 °C to 70 °C)
-200 °C to 150 °C	±0.15 °C	±0.4 °C
150 °C to 850 °C	±0.20 °C	±1.0 °C

Table 2. Temperature Accuracy (including noise)¹, 3-wire mode²

Measured Value	Typical (25 °C)	Maximum (-40 °C to 70 °C)
-200 °C to 150 °C	±0.20 °C	±0.5 °C
150 °C to 850 °C	±0.30 °C	±1.0 °C

Table 3. Resistance measurement accuracy (including noise)³, 4-wire mode

Measurement Conditions	Offset Error	Gain Error
Typical (25 °C)	±0.006 Ω	±0.007%
Maximum (-40 °C to 70 °C)	±0.083 Ω	±0.048%

Table 4. Resistance measurement accuracy (including noise)³, 3-wire mode

Measurement Conditions	Offset Error	Gain Error
Typical (25 °C)	±0.012 Ω	±0.007%
Maximum (-40 °C to 70 °C)	±0.101 Ω	±0.048%

¹ For high-speed mode, add 0.1 °C of error.

² The 3-wire specification assumes equal wire length connecting RTD+ terminal to RTD sensor and COM terminal to RTD sensor. If the lengths are unequal or there is a mismatch between the path resistances, use the following formula to evaluate additional error: °C error = $R_{\text{mismatch}} * 3.42 \text{ } ^\circ\text{C}/\Omega$

³ For high-speed mode, add 0.027 Ω of error.

Table 5. Stability

Mode	Offset Drift	Gain Drift
4-wire	$\pm 3 \text{ m}\Omega/\text{°C}$	$\pm 7 \text{ ppm}/\text{°C}$
3-wire	$\pm 3.3 \text{ m}\Omega/\text{°C}$	$\pm 7 \text{ ppm}/\text{°C}$

Noise

High-resolution mode	0.001 °Crms (0.3 mΩrms)
High-speed mode	0.02 °Crms (6 mΩrms)
Excitation current	1 mA per channel

Noise rejection

Normal mode (50/60 Hz)	
High-resolution mode	85 dB
High-speed mode	None
Common-mode rejection, channel-to-earth ground (50/60 Hz)	
High-resolution mode	>170 dB
High-speed mode	122 dB
Input bandwidth (high-resolution mode)	3.3 Hz

Figure 1. High-Resolution Filter Response^{4, 5}

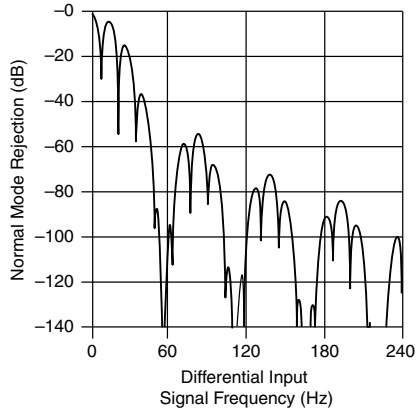

Overvoltage protection

±30 V, maximum

Power Requirements

Power consumption from chassis, maximum

Active mode 517 mW

Sleep mode 90 μ W

Thermal dissipation, maximum

Active mode 1.48 W

Sleep mode 0.76 W

Physical Characteristics

If you need to clean the module, wipe it with a dry towel.



Tip For two-dimensional drawings and three-dimensional models of the C Series module and connectors, visit ni.com/dimensions and search by module number.

Push-in spring-terminal wiring

Gauge 0.14 mm² to 1.5 mm² (26 AWG to 16 AWG)
copper conductor wire

Wire strip length 10 mm (0.394 in.) of insulation stripped from
the end

⁴ This image is provided courtesy of Linear Technology Corp.

⁵ High-speed filter response has the same characteristics as the high-resolution filter response except that the first notch is at 14 kHz.

Temperature rating	90 °C minimum
Wires per spring terminal	One wire per spring terminal; two wires per spring terminal using a 2-wire ferrule
Ferrules	0.14 mm ² to 1.5 mm ²
Connector securement	
Securement type	Screw flanges provided
Torque for screw flanges	0.2 N · m (1.80 lb · in.)
Weight	
NI 9216 with spring terminal	161 g (5.7 oz)
NI 9216 with DSUB	143 g (5.04 oz)

Safety Voltages

Connect only voltages that are within the following limits:

NI 9216 with Spring Terminal Isolation Voltages

Channel-to-channel	None
Channel-to-earth ground	
Continuous	250 Vrms, Measurement Category II
Withstand up to 5,000 m	3,000 Vrms, verified by a 5 s dielectric withstand test

Measurement Category II is for measurements performed on circuits directly connected to the electrical distribution system. This category refers to local-level electrical distribution, such as that provided by a standard wall outlet, for example, 115 V for U.S. or 230 V for Europe.



Caution Do not connect the NI 9216 with spring terminal to signals or use for measurements within Measurement Categories III or IV.

NI 9216 with DSUB Isolation Voltages

Channel-to-channel	None
Channel-to-earth ground	
Continuous	60 VDC, Measurement Category I
Withstand	
Up to 3,000 m	1,000 Vrms, verified by a 5 s dielectric withstand test
Up to 5,000 m	860 Vrms, verified by a 5 s dielectric withstand test

Measurement Category I is for measurements performed on circuits not directly connected to the electrical distribution system referred to as *MAINS* voltage. MAINS is a hazardous live electrical supply system that powers equipment. This category is for measurements of voltages from specially protected secondary circuits. Such voltage measurements include signal levels, special equipment, limited-energy parts of equipment, circuits powered by regulated low-voltage sources, and electronics.



Caution Do not connect the NI 9216 with DSUB to signals or use for measurements within Measurement Categories II, III, or IV.



Note Measurement Categories CAT I and CAT O are equivalent. These test and measurement circuits are not intended for direct connection to the MAINS building installations of Measurement Categories CAT II, CAT III, or CAT IV.

Hazardous Locations

U.S. (UL)	Class I, Division 2, Groups A, B, C, D, T4; Class I, Zone 2, AEx nA IIC T4
Canada (C-UL)	Class I, Division 2, Groups A, B, C, D, T4; Class I, Zone 2, Ex nA IIC T4
Europe (ATEX) and International (IECEX)	Ex nA IIC T4 Gc

Safety and Hazardous Locations Standards

This product is designed to meet the requirements of the following electrical equipment safety standards for measurement, control, and laboratory use:

- IEC 61010-1, EN 61010-1
- UL 61010-1, CSA 61010-1
- EN 60079-0:2012, EN 60079-15:2010
- IEC 60079-0: Ed 6, IEC 60079-15; Ed 4
- UL 60079-0; Ed 6, UL 60079-15; Ed 4
- CSA 60079-0:2011, CSA 60079-15:2012



Note For UL and other safety certifications, refer to the product label or the [Online Product Certification](#) section.

Electromagnetic Compatibility

This product meets the requirements of the following EMC standards for electrical equipment for measurement, control, and laboratory use:

- EN 61326-1 (IEC 61326-1): Class A emissions; Industrial immunity
- EN 55011 (CISPR 11): Group 1, Class A emissions
- EN 55022 (CISPR 22): Class A emissions
- EN 55024 (CISPR 24): Immunity
- AS/NZS CISPR 11: Group 1, Class A emissions

- AS/NZS CISPR 22: Class A emissions
- FCC 47 CFR Part 15B: Class A emissions
- ICES-001: Class A emissions



Note In the United States (per FCC 47 CFR), Class A equipment is intended for use in commercial, light-industrial, and heavy-industrial locations. In Europe, Canada, Australia and New Zealand (per CISPR 11) Class A equipment is intended for use only in heavy-industrial locations.



Note Group 1 equipment (per CISPR 11) is any industrial, scientific, or medical equipment that does not intentionally generate radio frequency energy for the treatment of material or inspection/analysis purposes.



Note For EMC declarations and certifications, and additional information, refer to the [Online Product Certification](#) section.

CE Compliance

This product meets the essential requirements of applicable European Directives, as follows:

- 2014/35/EU; Low-Voltage Directive (safety)
- 2014/30/EU; Electromagnetic Compatibility Directive (EMC)
- 2014/34/EU; Potentially Explosive Atmospheres (ATEX)

Online Product Certification

Refer to the product Declaration of Conformity (DoC) for additional regulatory compliance information. To obtain product certifications and the DoC for this product, visit ni.com/certification, search by model number or product line, and click the appropriate link in the Certification column.

Shock and Vibration

To meet these specifications, you must panel mount the system.

Operating vibration

Random (IEC 60068-2-64)	5 g _{rms} , 10 Hz to 500 Hz
Sinusoidal (IEC 60068-2-6)	5 g, 10 Hz to 500 Hz
Operating shock (IEC 60068-2-27)	30 g, 11 ms half sine; 50 g, 3 ms half sine; 18 shocks at 6 orientations

Environmental

Refer to the manual for the chassis you are using for more information about meeting these specifications.

Operating temperature (IEC 60068-2-1, IEC 60068-2-2)	-40 °C to 70 °C
Storage temperature (IEC 60068-2-1, IEC 60068-2-2)	-40 °C to 85 °C
Ingress protection	IP40
Operating humidity (IEC 60068-2-78)	10% RH to 90% RH, noncondensing
Storage humidity (IEC 60068-2-78)	5% RH to 95% RH, noncondensing
Pollution Degree	2
Maximum altitude	5,000 m

Indoor use only.

Environmental Management

NI is committed to designing and manufacturing products in an environmentally responsible manner. NI recognizes that eliminating certain hazardous substances from our products is beneficial to the environment and to NI customers.

For additional environmental information, refer to the *Minimize Our Environmental Impact* web page at ni.com/environment. This page contains the environmental regulations and directives with which NI complies, as well as other environmental information not included in this document.

Waste Electrical and Electronic Equipment (WEEE)



EU Customers At the end of the product life cycle, all NI products must be disposed of according to local laws and regulations. For more information about how to recycle NI products in your region, visit ni.com/environment/weee.

电子信息产品污染控制管理办法（中国 RoHS）



中国客户 National Instruments 符合中国电子信息产品中限制使用某些有害物质指令 (RoHS)。关于 National Instruments 中国 RoHS 合规性信息，请登录 ni.com/environment/rohs_china。(For information about China RoHS compliance, go to ni.com/environment/rohs_china.)

Calibration

You can obtain the calibration certificate and information about calibration services for the NI 9216 at ni.com/calibration.

Calibration interval	1 year
----------------------	--------

Refer to the *NI Trademarks and Logo Guidelines* at ni.com/trademarks for information on NI trademarks. Other product and company names mentioned herein are trademarks or trade names of their respective companies. For patents covering NI products/technology, refer to the appropriate location: **Help»Patents** in your software, the `patents.txt` file on your media, or the *National Instruments Patent Notice* at ni.com/patents. You can find information about end-user license agreements (EULAs) and third-party legal notices in the readme file for your NI product. Refer to the *Export Compliance Information* at ni.com/legal/export-compliance for the NI global trade compliance policy and how to obtain relevant HTS codes, ECCNs, and other import/export data. NI MAKES NO EXPRESS OR IMPLIED WARRANTIES AS TO THE ACCURACY OF THE INFORMATION CONTAINED HEREIN AND SHALL NOT BE LIABLE FOR ANY ERRORS. U.S. Government Customers: The data contained in this manual was developed at private expense and is subject to the applicable limited rights and restricted data rights as set forth in FAR 52.227-14, DFAR 252.227-7014, and DFAR 252.227-7015.

© 2017 National Instruments. All rights reserved.

378022A-02 Jan17