



Lab Course / Praktikum

***Project Management and Software Development for
Medical Applications***

UML: Unified Modeling Language – 07/11/2023

Winter Semester 2023/24

Conducted by:

Felix Tristram



Agenda

Part 1

- Software Design
- What is UML?
- Class Diagrams
- Use Case Diagrams

Short break (if needed)

Part 2

- Component Diagrams
- Sequence Diagrams
- Activity Diagrams
- UML Tools





QUIZ TIME!

Each chapter will be followed by some questions to be discussed by the students.



Software Development Life Cycle

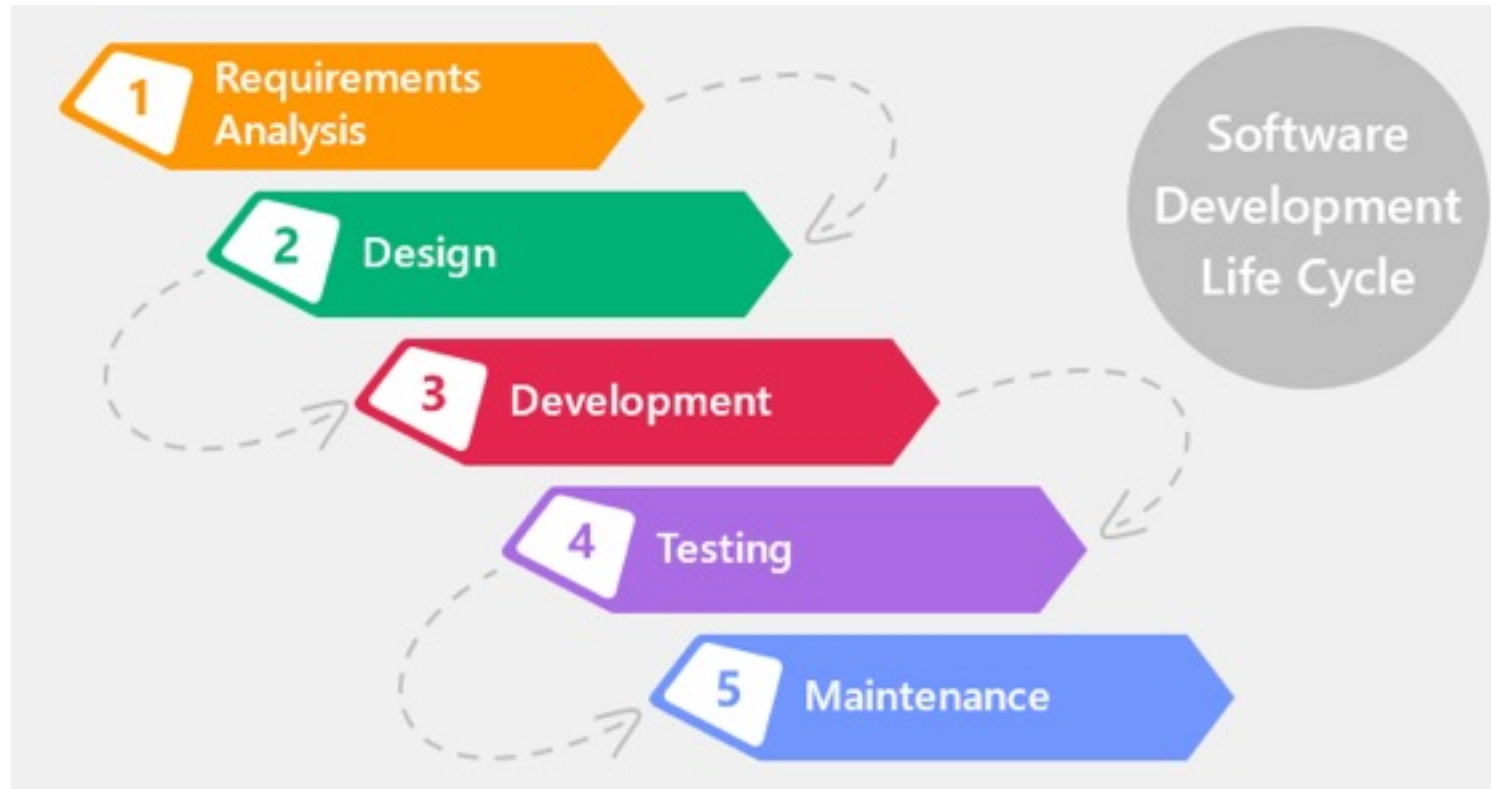

Software Development Life Cycle

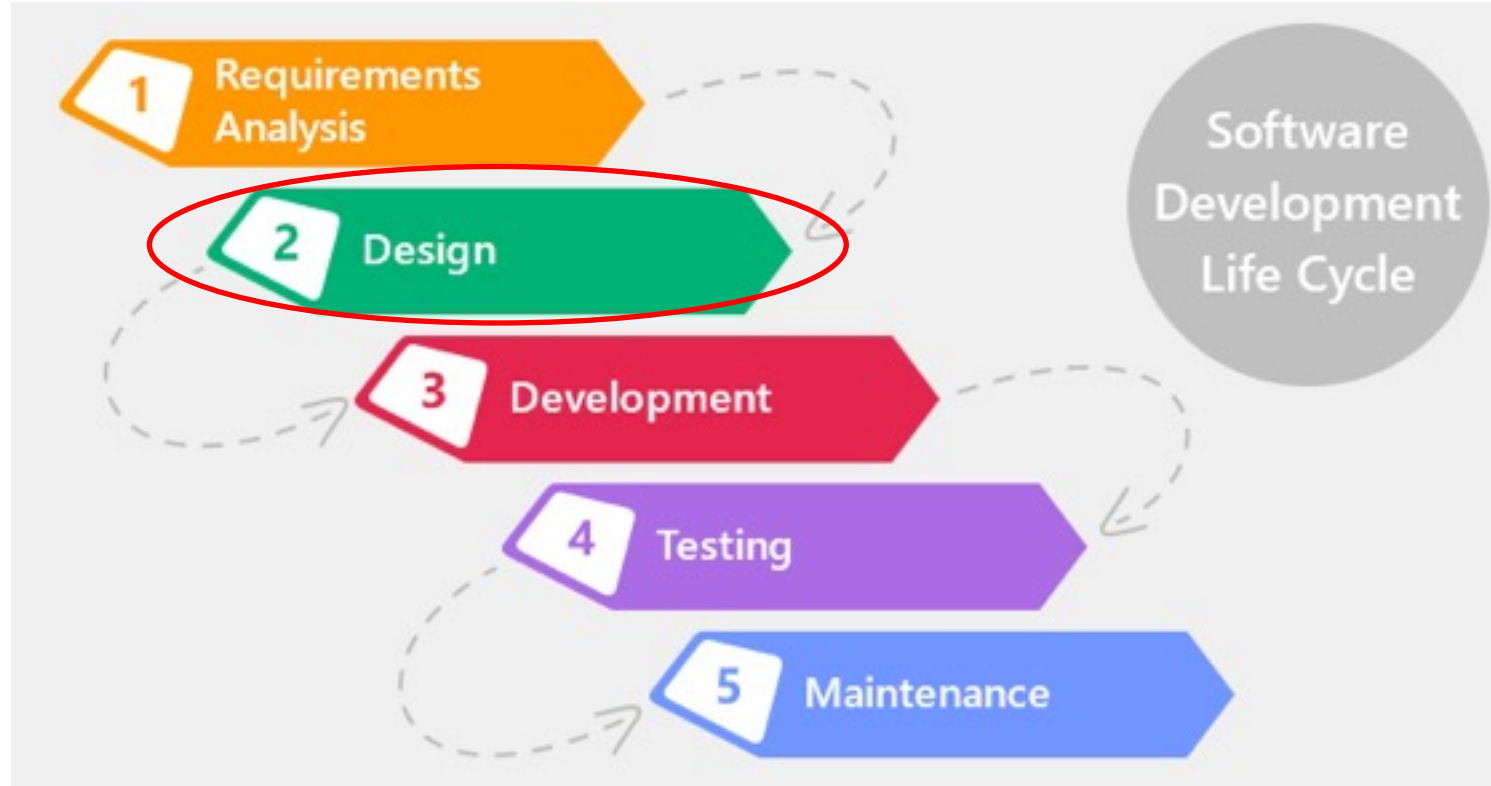

Software Design is about **modeling** software systems



The Importance of Modeling

- A model is a simplification of reality.
- We build models so we can better understand the system we are developing

Benefits:

- Visualization:
 - Improves the productivity of the development team
 - Permits early exploration of alternatives
- Behavior and Structure:
 - Improves the understanding of the system
- System Template:
 - Reduces the number of defects in the final code
 - Increases the decomposition and modularization of the system
 - Facilitates the system's evolution and maintenance
- Documentation

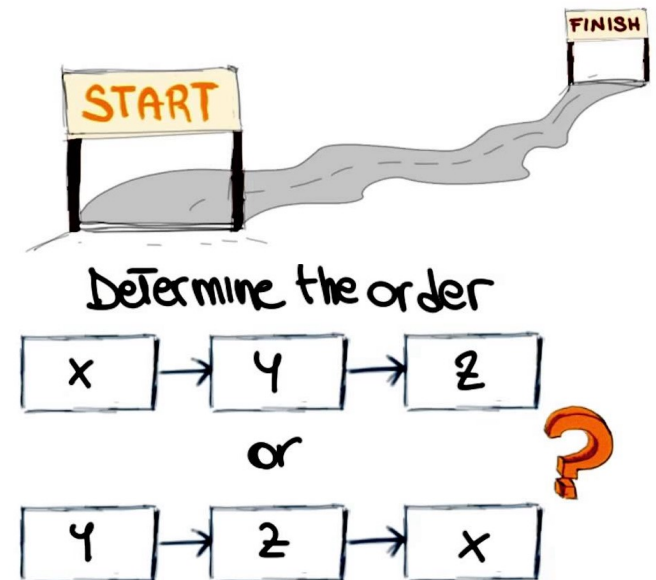

Visuals Help in Software Design

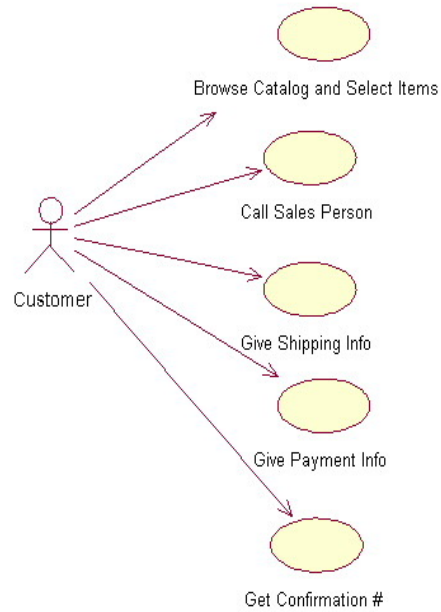

Clients/stakeholders

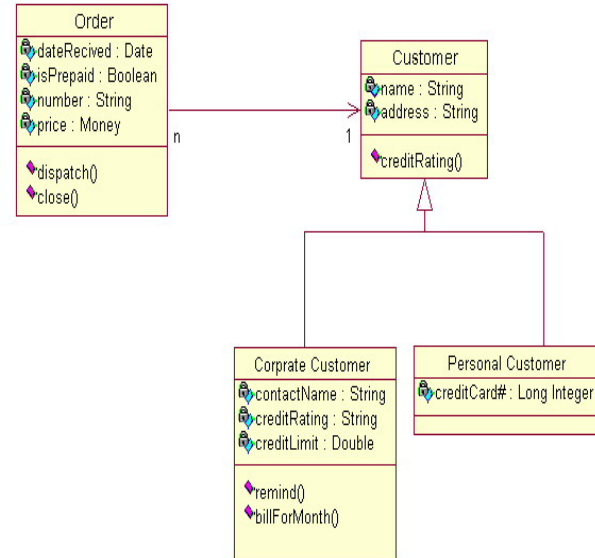

Programmers

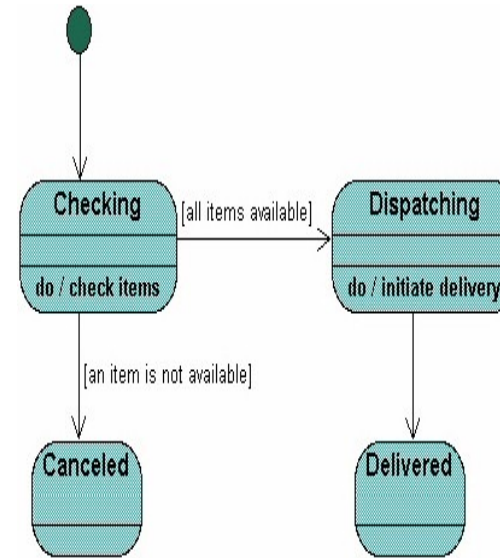

Analzers



Unified Modeling Language (UML)...

... is an industry standard for visualizing, specifying, constructing, and documenting the artifacts of a software system.

... is not for the sake of creating diagrams, however...

... it is about **creating a model** which you visualize in a diagram according to the de facto standard modeling language.

... is extended and updated over time:

1996 UML 1.0
2005 UML 2.0
2009 UML 2.2
2015 UML 2.5
2017 UML 2.5.1

<https://www.omg.org/spec/UML/>



UML Is a Formal Visual Language

- UML offers a framework for deriving simplified models of a complex reality
- UML is a graphics-based language with syntax and semantics
 - Every valid structure has a meaning (semantics)
 - There are rules defining how structures may be put together (syntax)
 - Programming platform independent
- UML is a great communication tool
 - Natural language is often imprecise and source code too detailed
 - It standardizes a very natural, visual communication approach: drawings
 - UML moves us from fragmentation to standardization while offering flexibility



Structure and Behavior Are The Main Two UML Types

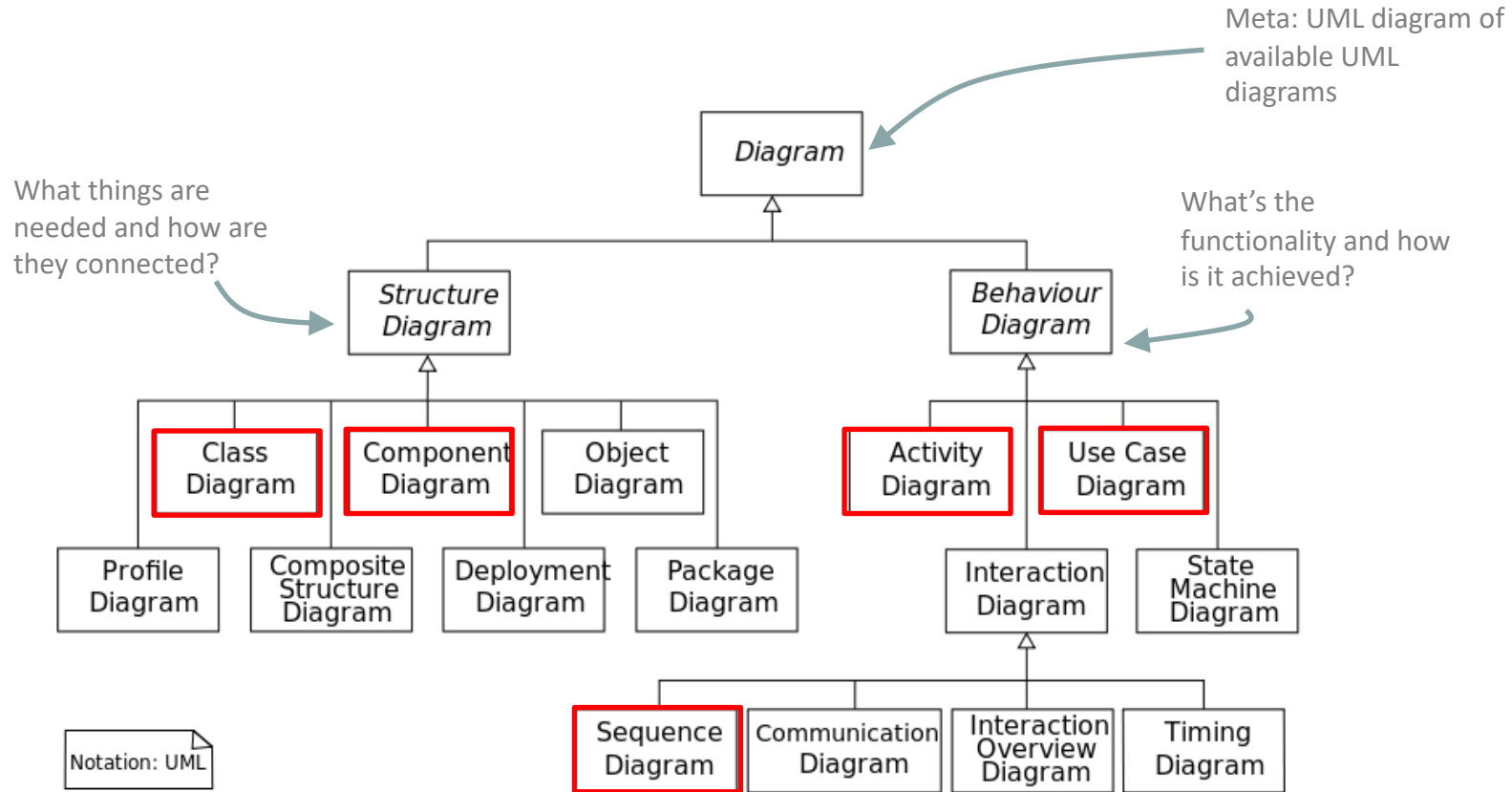



QUIZ TIME!

1. In which phase of the Software Development Cycle are UML diagrams mainly created?
2. Name two benefits of software models!
3. How would you define UML in your own words?
4. What is the difference between Structure and Behaviour Diagrams?

Class Diagram - Introduction

- Is a **static structure** diagram based on classes
- No logic or functionality included
- Probably the most popular and most used diagram type
 - Still **UML diagram != UML class diagram**
 - **INSTEAD:** Planning should start with other diagrams!
- Consists of
 1. Classes: attributes, operations or methods
 2. Relationships among the classes.

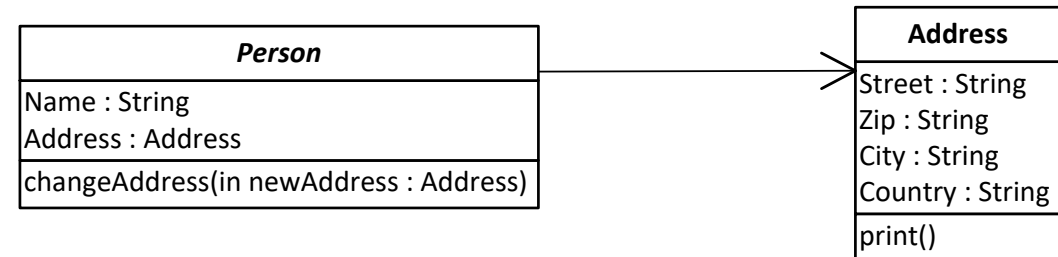

Class Diagram – Syntax

Visibility:

- + public
- private
- # protected
- / derived

Methods contain:

- Parameters (and default values)
- Accessibility: e.g. static

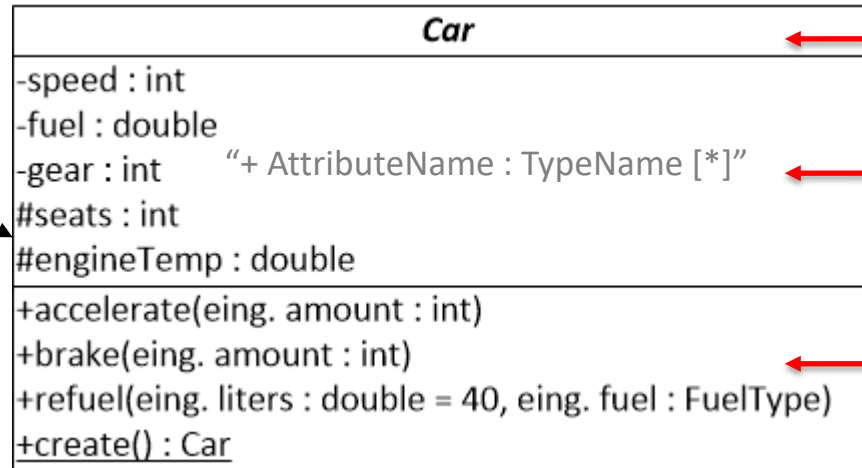

Name

Attributes

Methods/
Operations

Can have different levels of detail!!

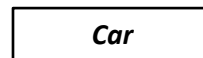

Name *Italic* if abstract

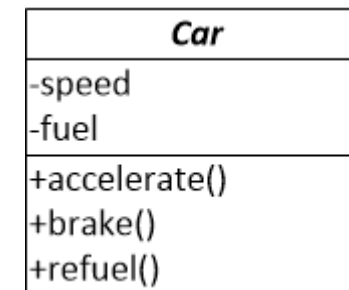
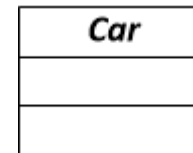

Class Diagram - Relationships

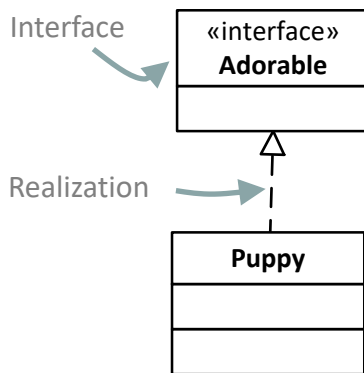
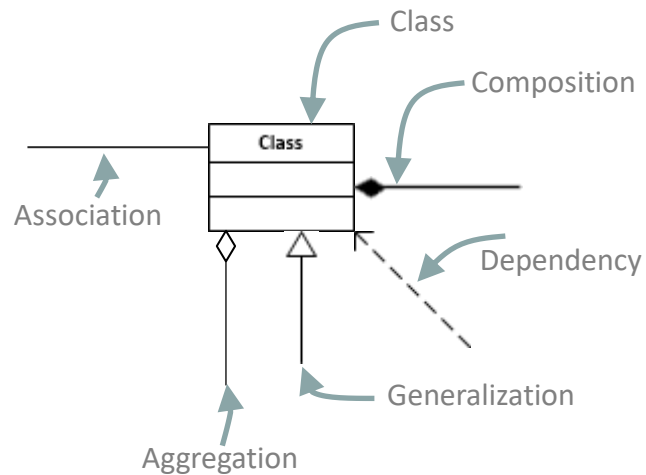

- this class is associated with — this class
- this class is dependent upon - - - > this class
- this class inherits from —▷ this class
- this class has —○ this interface
- this class is a realisation of - - - ▷ this class
- you can navigate from this class to —▷ this class
- these classes compose without belonging to —◇ this class
- these classes compose and are contained by —◆ this class
- this object sends a synchronous message to —▶ this object
- this object sends an asynchronous message to —▷ this object

Multiplicity: How many objects can participate in the relationship. Indicates the number of instances of one class linked to instances of the other class.

- 0 or more: *
- 1 or more **1..***
- From 2 to 4: **2..4**
- Only 7: **7**



Class Diagram - Dependencies

- Means that one class makes use of another class at some point in time
- Can be read as “... needs a ...” or “... uses a ...”
- Weakest form of relation after “no relation”
- Typically used if the independent class is a parameter of an operation of the dependent class
- Stereotypes are commonly used to highlight the precise nature of a dependency, e.g. <<displays>>, <<calls>>, <<creates>>

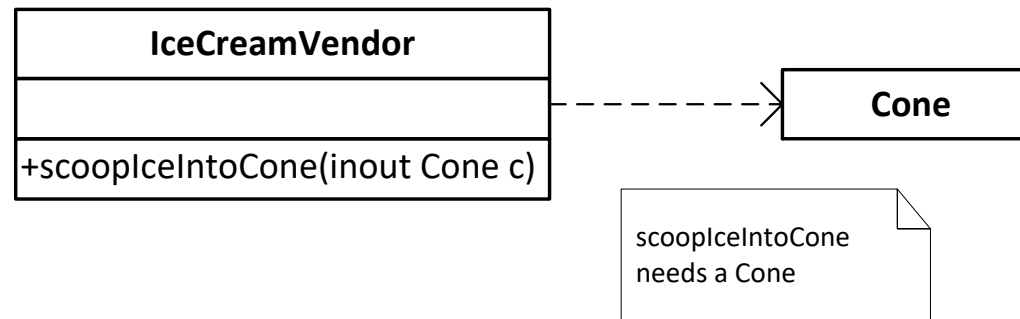

Class Diagram - Associations

- Stronger relationship than dependencies
- Implies that two classes are coupled over a long period of time
- Can be read as “... has a ...” or “... knows of ...”
- Typically used if one class has an attribute with a type of another class

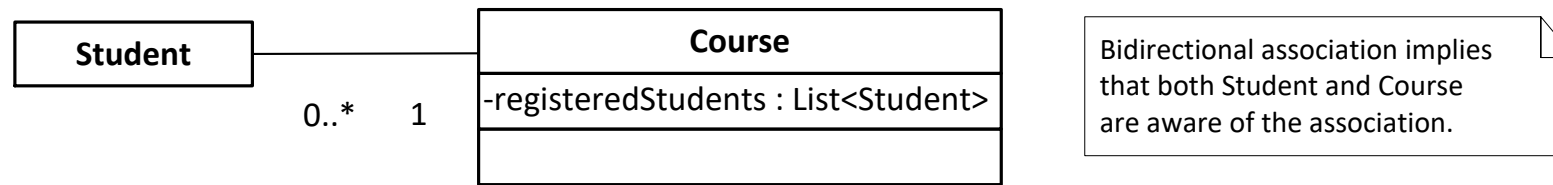

- Associations can be unidirectional to indicate navigability

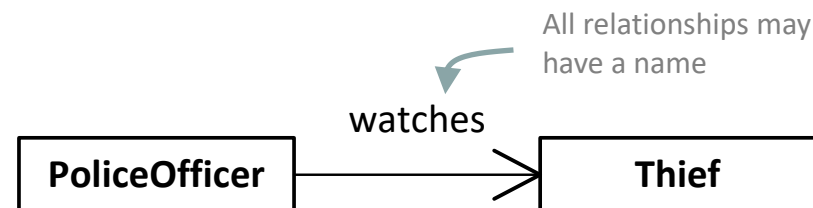

Class Diagram - Composition and Aggregation

- Both aggregation and composition represent a **whole-part relationship**
- The main difference is how dependent the “part” is on the “whole”
- **Aggregation:** parts do not depend on lifecycle of the whole

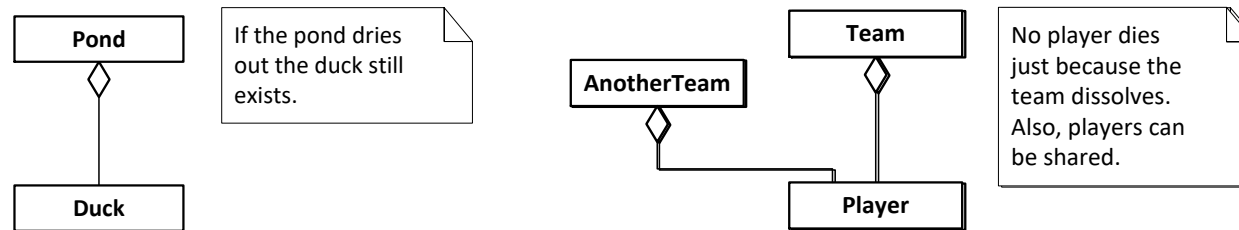

- **Composition:** parts depend on the lifecycle of the whole, they are “owned”

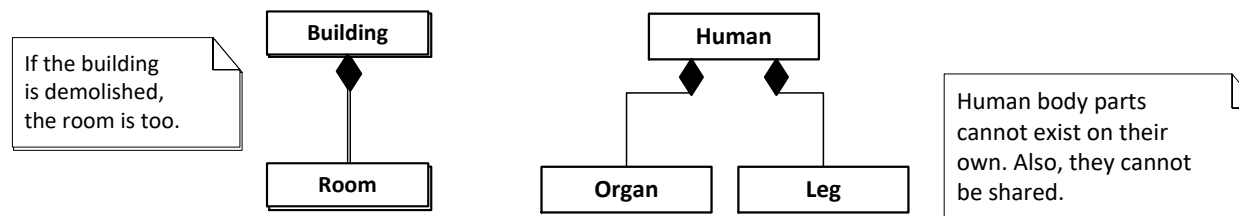

Class Diagram – Generalization/Specialization

- Used to show inheritance
- Reads as “... is a ...”

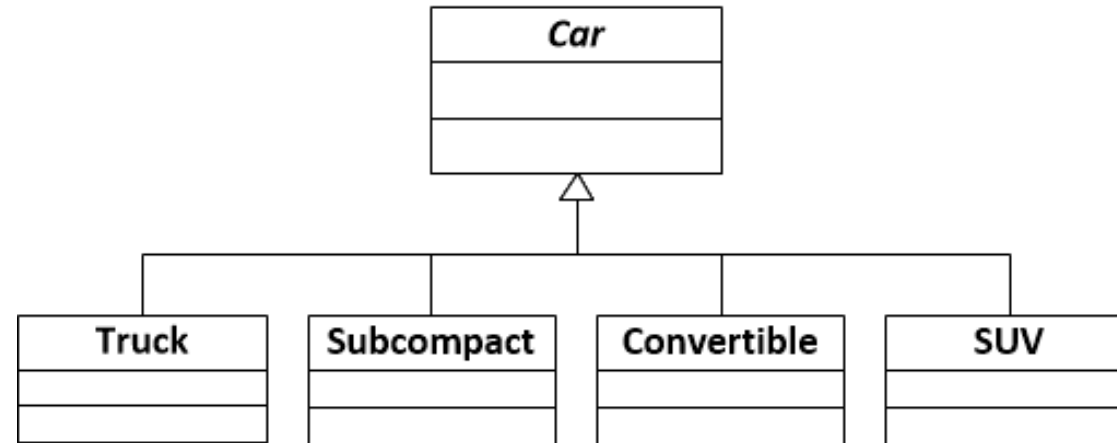

Class Diagram - Summary

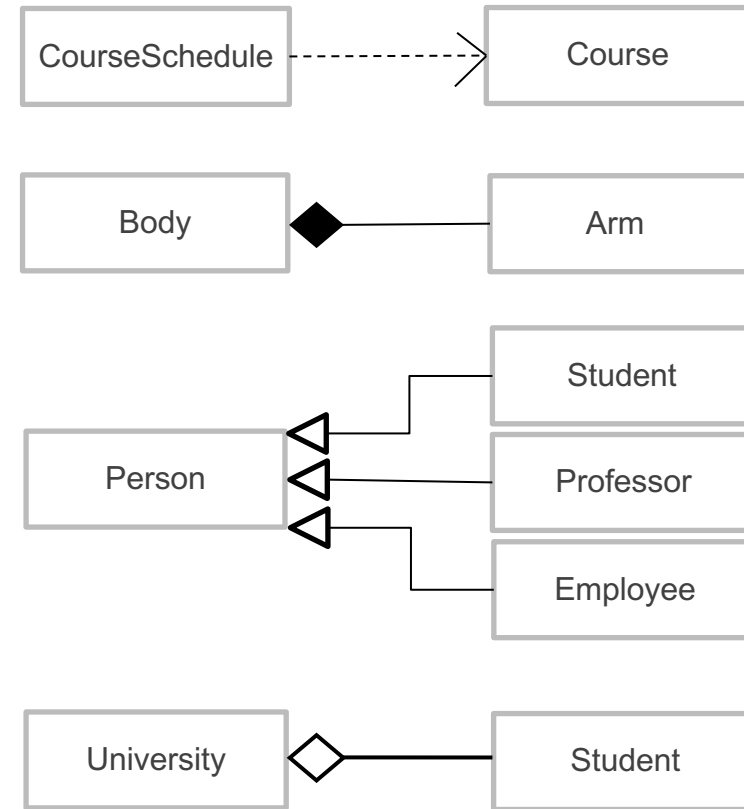
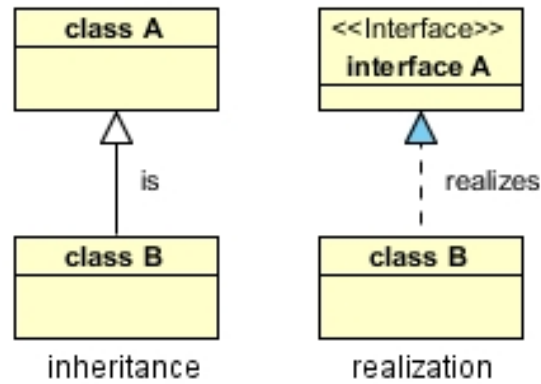
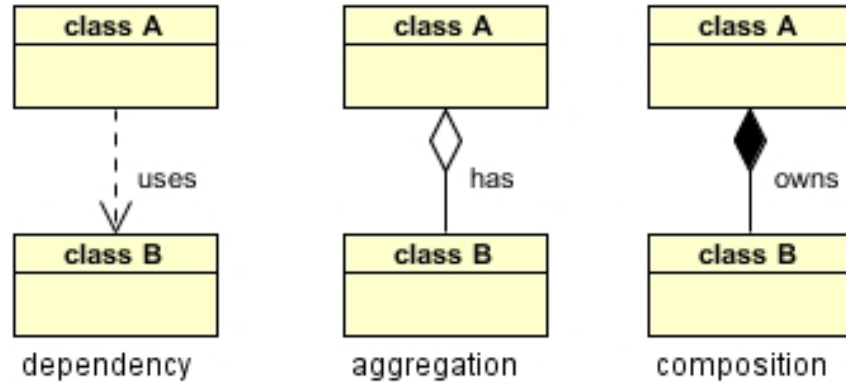



QUIZ TIME!

1. Define Class Diagrams in your own words!
2. What are the main components of a Class Diagram?
3. Does a Class Diagram describe a static or dynamic view of a software system?
4. Explain the difference between Aggregation and Composition!

Quiz Time cont.

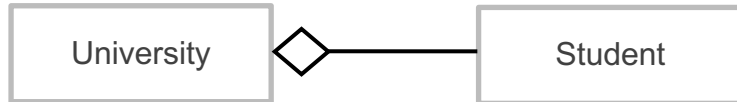

Which statements are true?

5. "Student" is part of "University".
6. If an instance of "University" is deleted, all contained instances of "Student" are also deleted.
7. If an instance of "University" is deleted, the contained instances of "Student" are not affected.
8. "University" is part of "Student".
9. If an instance of "Student" is deleted, all contained instances of "University" are also deleted.

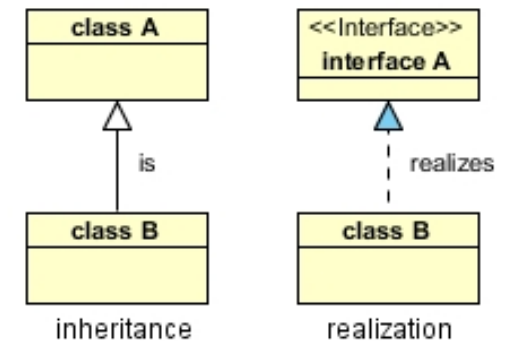
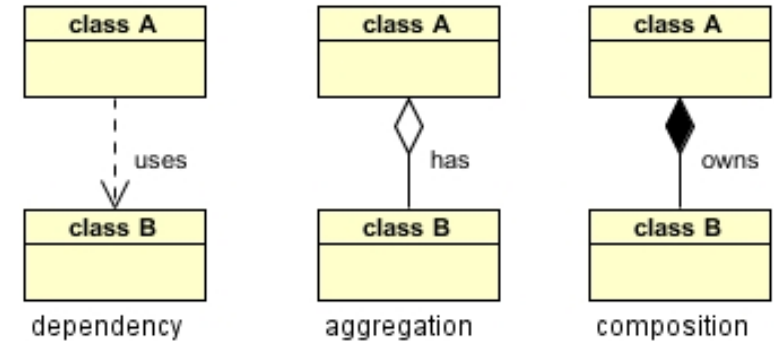

Quiz Time cont.

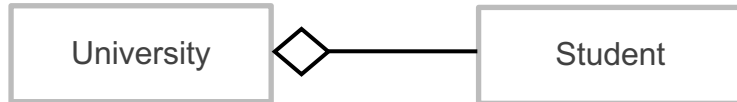

Which statements are true?

- 5. "Student" is part of "University". ✓
- 6. If an instance of "University" is deleted, all contained instances of "Student" are also deleted. ✗
- 7. If an instance of "University" is deleted, the contained instances of "Student" are not affected. ✓
- 8. "University" is part of "Student". ✗
- 9. If an instance of "Student" is deleted, all contained instances of "University" are also deleted. ✗

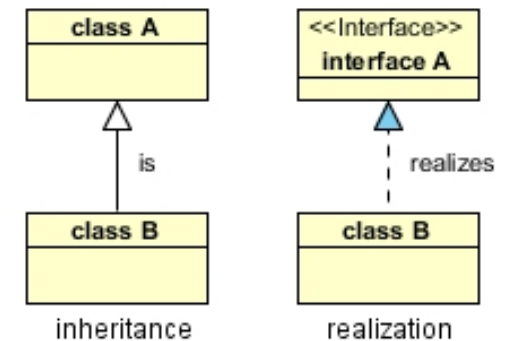
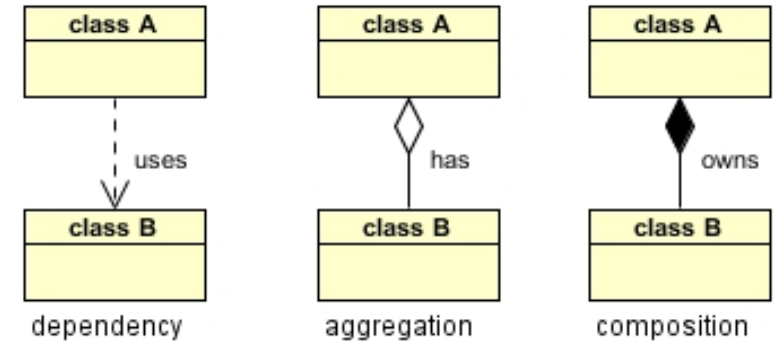

Use Case Diagram

- A use case diagram shows the **functionality** of a system
 - “What can a system do?”, not “How does it do it?”
- It consists of named entities of functionality (use cases) and entities triggering the use cases or receiving their output (actors)
- Very important for requirements analysis: Identify all users and functionalities

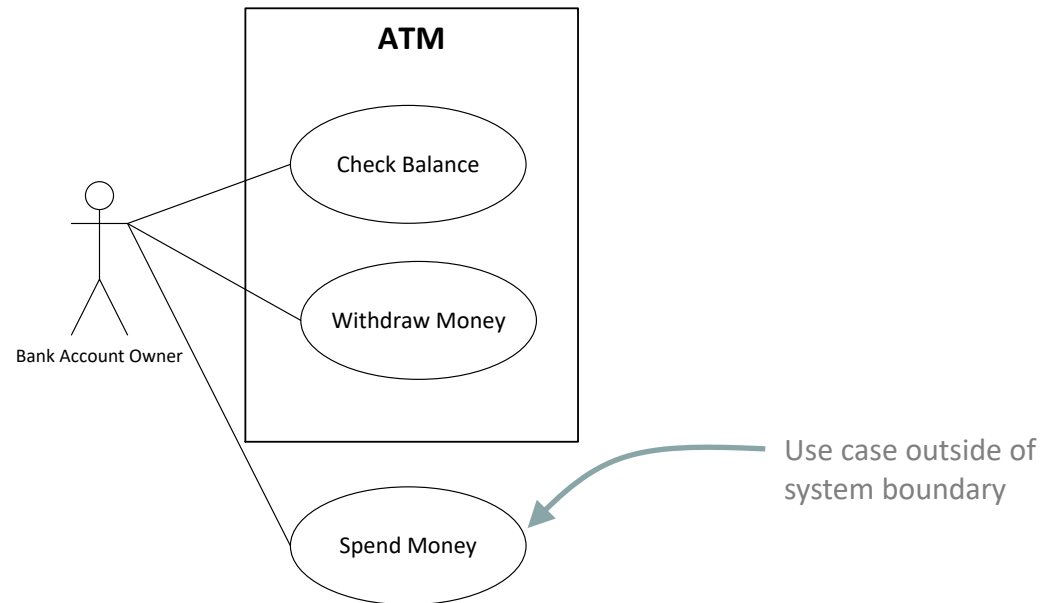

Elements of Use Case Diagrams (I/II)



- Actors
 - Humans or external systems, interacting with the system
 - Often custom representations are used



- Use cases
 - A piece of functionality, provided by the system
 - Best practice for naming: [action verb] + [object]
 - E.g. “place order”, “invite attendees”, “pay invoice”
 - Use cases do **not** describe the process (the single steps) of how this interaction takes place, this might be documented within the use case description.

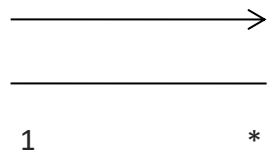

- Actor/Use Case Association
 - Indicates that the actor initiates a use case or receives results from the use case, or both → directionality optional
 - May show multiplicities
 - **No Actor/Actor associations!**



Elements of Use Case Diagrams (II/II)

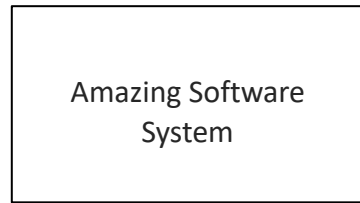

- System boundaries
 - Box with name, use cases inside box, actors outside box
 - Yet, showing use cases outside your system can be useful



- Use Case Extension
 - Indicates additional functionality on top of a base use case
 - Base use case is complete use case on its own

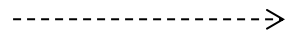

- Use Case Inclusion
 - Indicates that base use case is not complete on its own but *includes* one or more other use cases
 - Used to group smaller use cases into a large one or to factor out common functionality that is included by several use cases

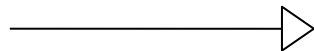

- Generalizations (Actor/Actor or Use Case/Use Case)



- Comments



Use Case Diagram Example: Online Shopping System

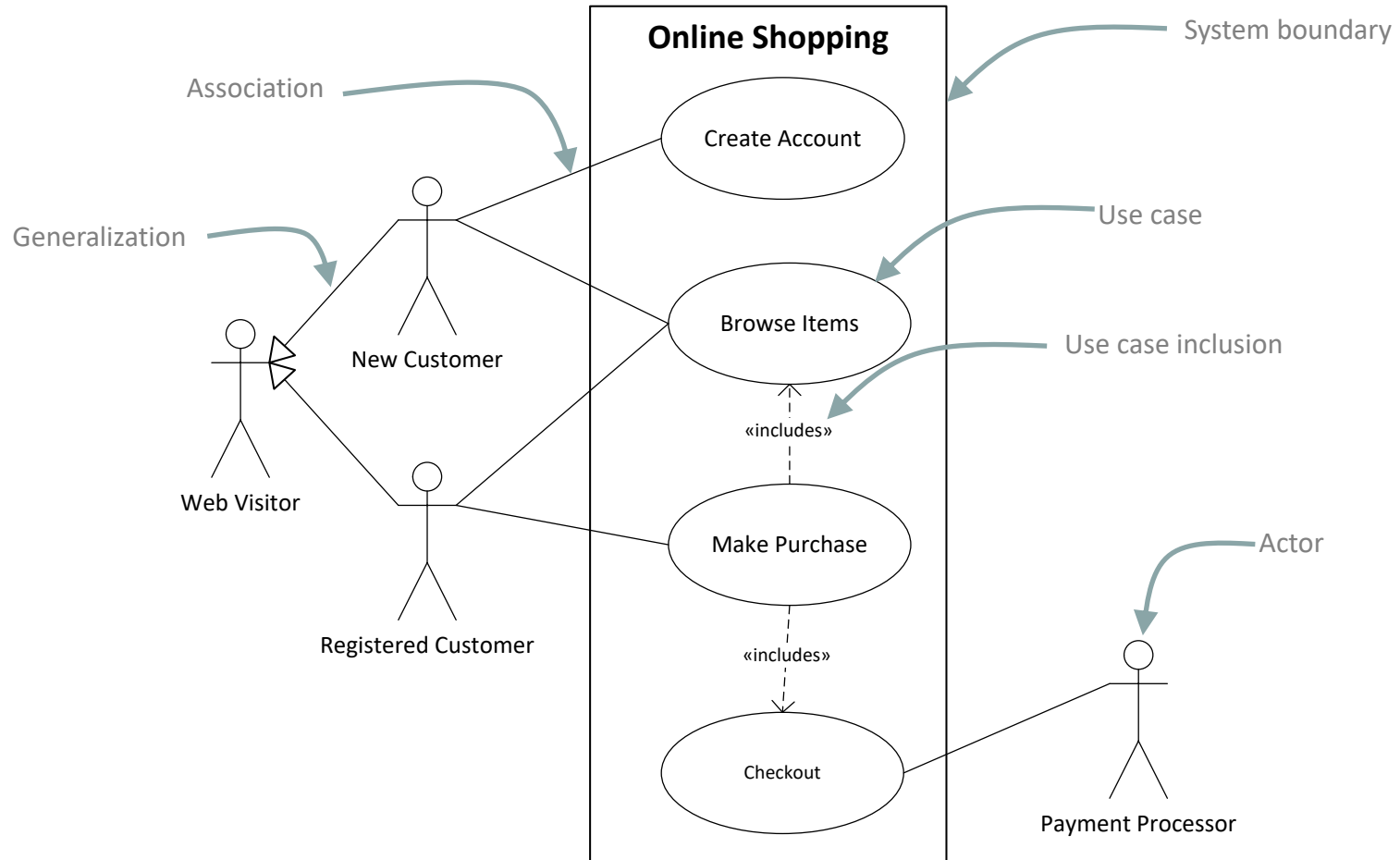

Use-Case Diagram Example: Multiplicities

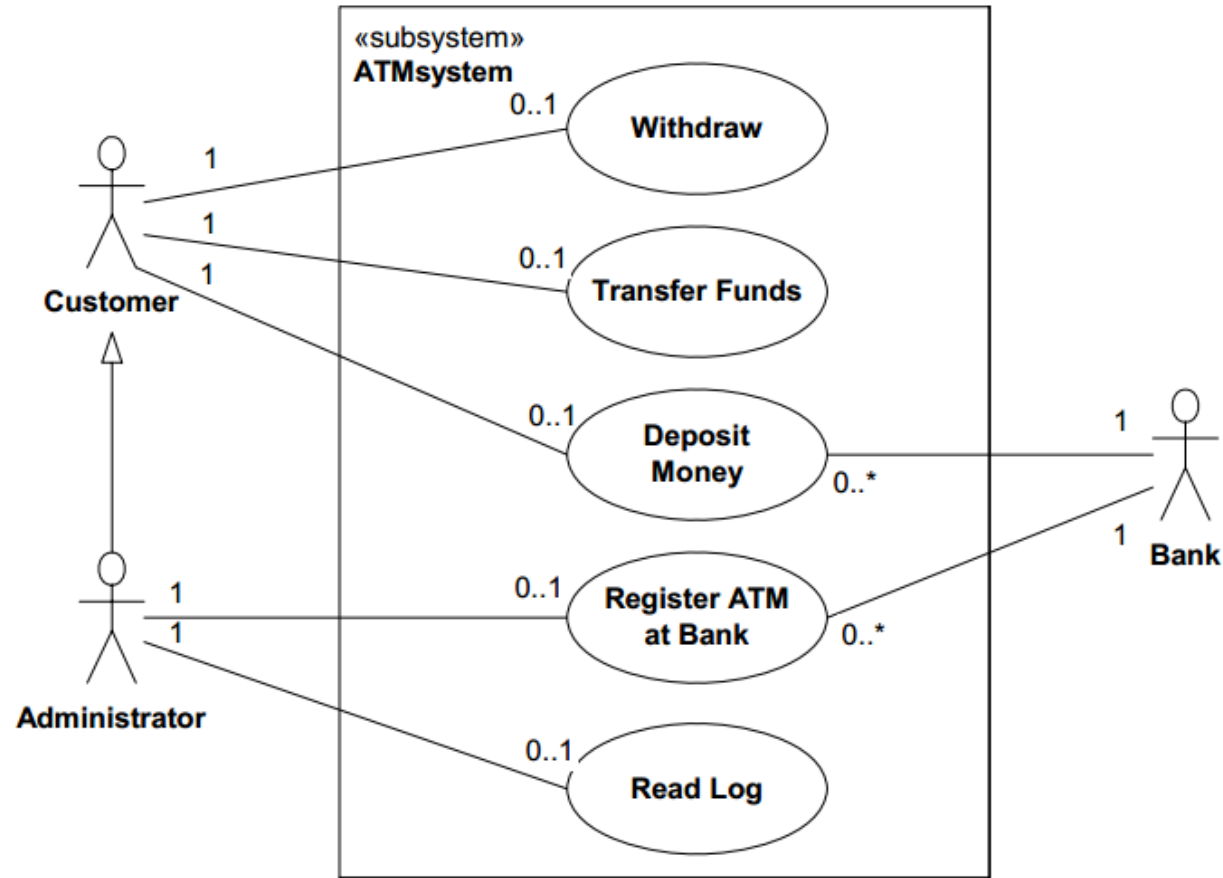

From the UML Superstructure Specification





QUIZ TIME!

1. Describe the Use Case Diagram in your own words!
1. Which of the following statements correctly characterize use cases?
 - a) Use cases can be derived from the clients' requests.
 - b) Use cases specify the procedural process within a system.
 - c) Use cases specify the functionalities that the system should have.
 - d) Use cases are suitable for modeling interfaces between two systems.

Quiz Time cont.

Which of the following use cases are correct use cases when you want to design a use case diagram for an online book shop?

3. Look for a book
4. Cancel order
5. Do not order a book
6. Login
7. Enter book title
8. Order a book
9. Enter credit card details



Quiz Time cont.

Which of the following use cases are correct use cases when you want to design a use case diagram for an online book shop?

3. Look for a book ✓

4. Cancel order ✓

5. Do not order a book ✗

6. Login ✗

7. Enter book title ✗

8. Order a book ✓

9. Enter credit card details ✗

N.B.: Use cases do not describe the single steps of how this interaction takes place. A user will not just enter his credit card details; this might be one single step within the use case "Order a book".



Structure and Behavior Are The Main Two UML Types

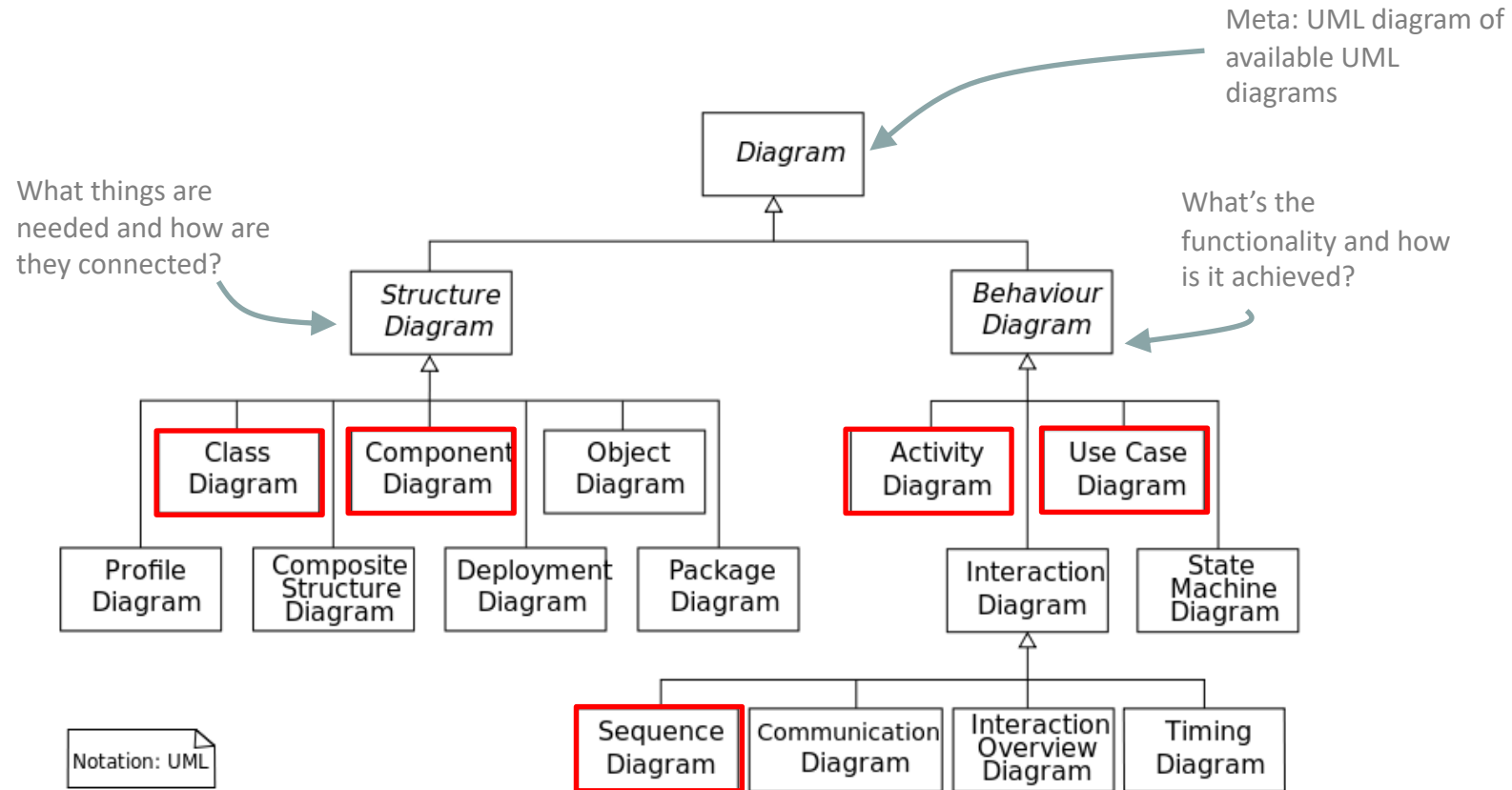

Component Diagram

- Show the **structural relationships** between the components of a system (higher level than class diagram).
- Very easy type of diagram, related to class diagram
- Components are highly cohesive and encapsulated high-level design units (“black boxes”).
 - Often components are classes but not necessarily
- The communication is through interfaces with the inputs required and services provided.
- Can be used independent of OO programming languages

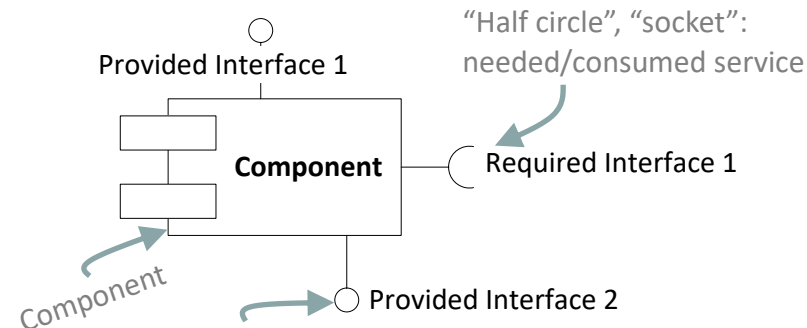

Component Diagram - Examples

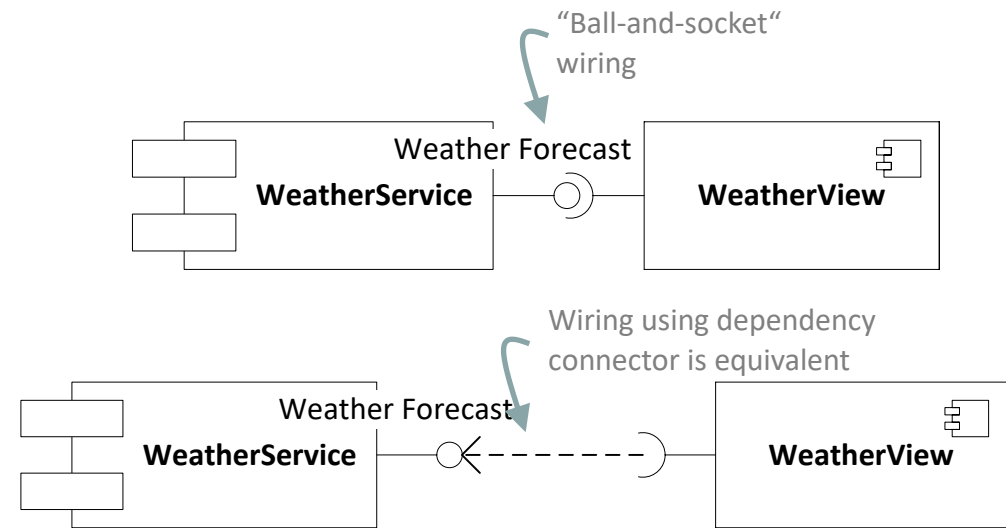
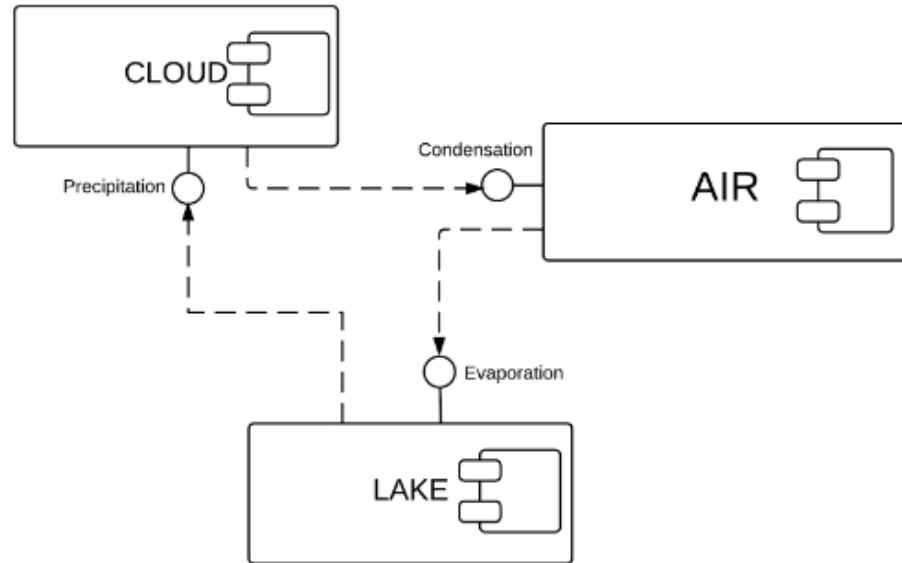

More complex example for Component Diagrams

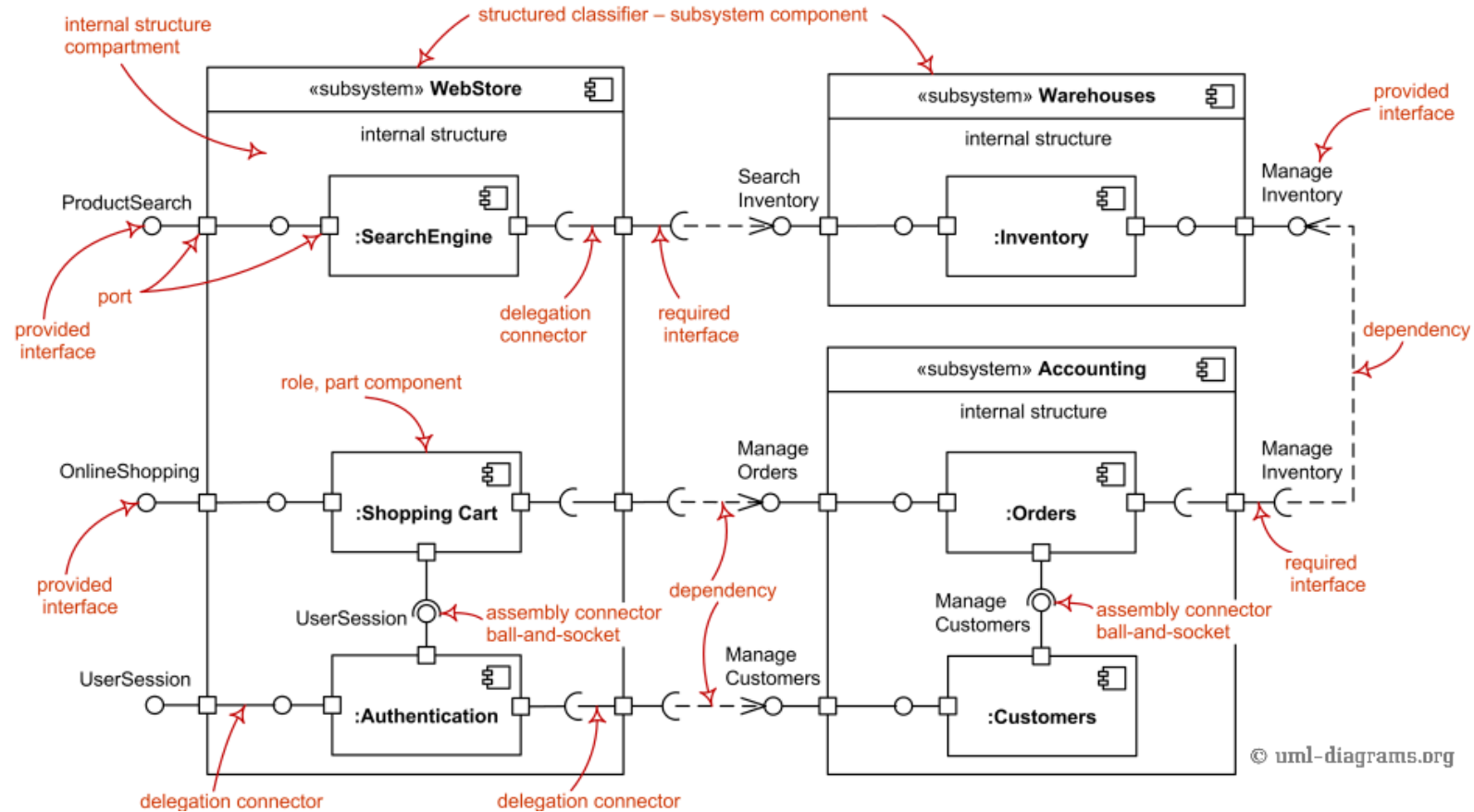

<http://www.uml-diagrams.org/component-diagrams.html>





QUIZ TIME!

1. Are Component Diagrams Behaviour or Structure Diagrams?
2. What are Component Diagrams used for?
3. Name two examples for components!



Sequence Diagram

- Is an interaction diagram
 - Models interaction of entities in a system with each other
- Typically used to **show system behavior** and model the logic in a specific use case
 - “How?” not “What?”
- The horizontal dimension shows the objects participating in the interaction
- The vertical dimension shows messages in their relative order

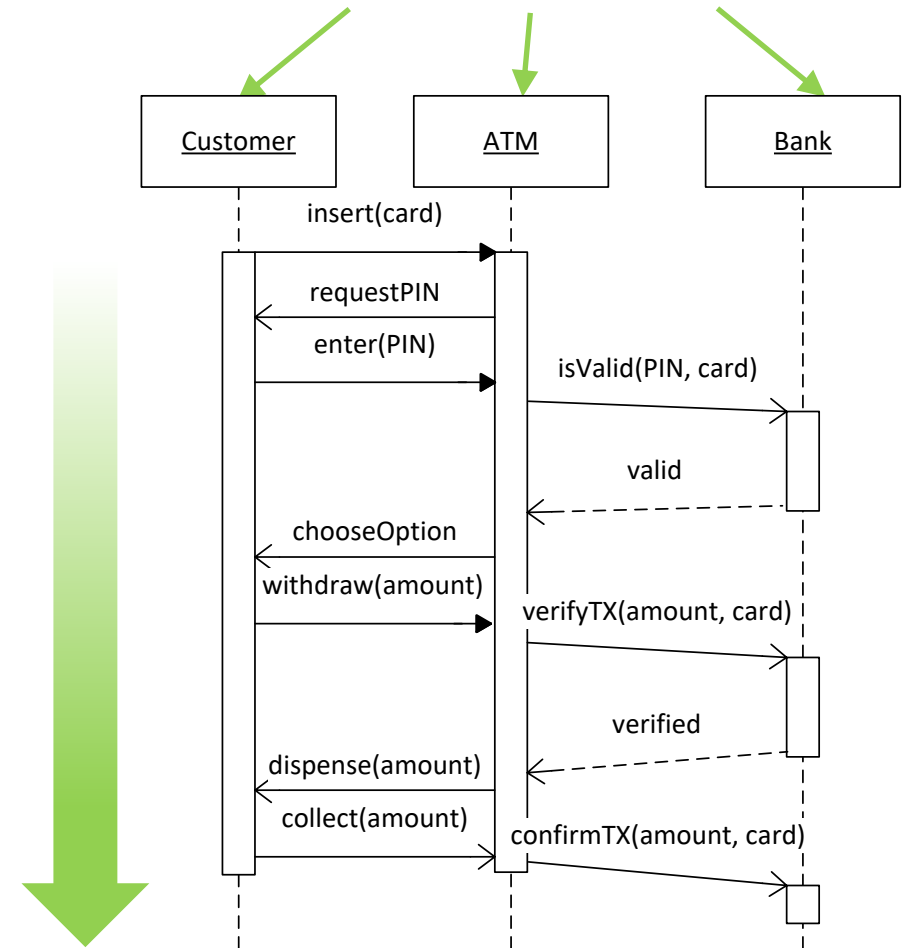

Sequence Diagram - Elements

- Objects (interaction participants) with lifeline
 - Notation in software engineering: "Name:Type"
 - Show how long object is in existence
 - Can explicitly put an "x" at the end to highlight destruction
- Activation blocks/bars (formally "Execution specification")
 - Participant is sending, waiting, in general: busy
- Messages (synchronous, asynchronous, return)
 - Synchronous, caller blocks
 - Asynchronous, caller does not block
 - Return

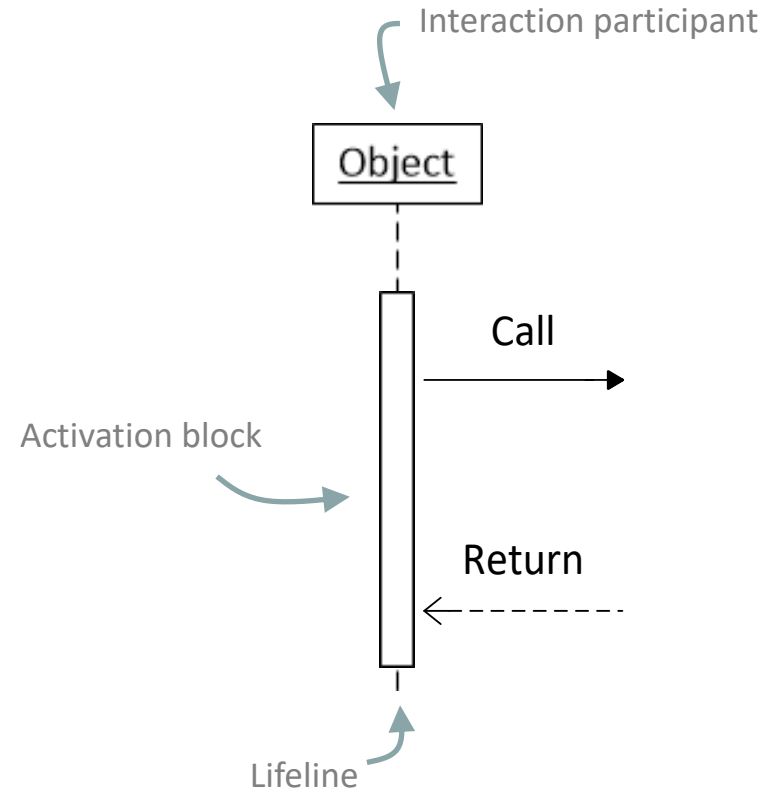
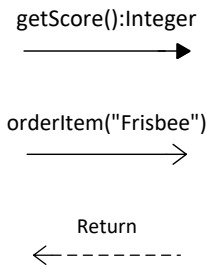

- General notation "*Name(Parameters):Return Type*"



Sequence Diagram - Examples

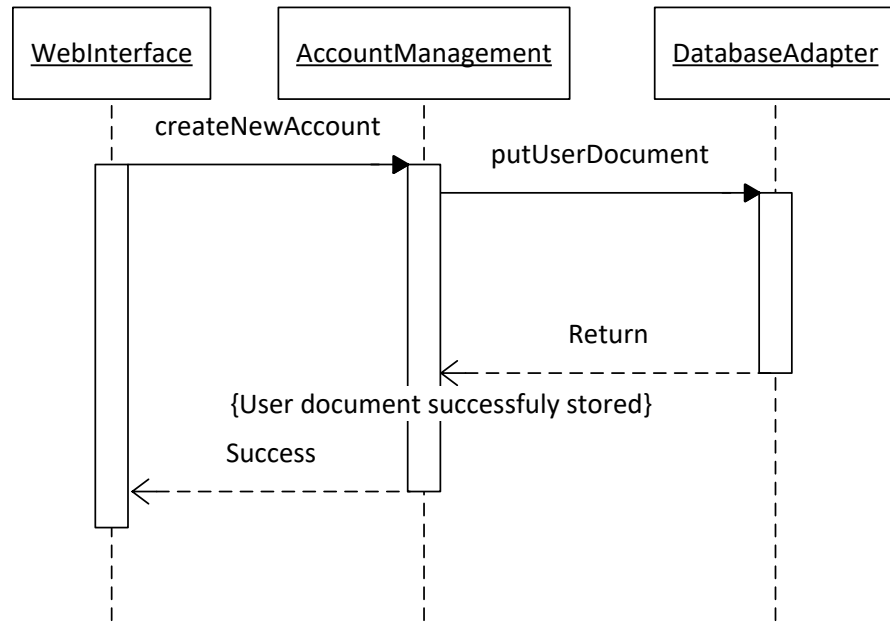

State invariant needs to be true for the rest of the interaction to be valid.

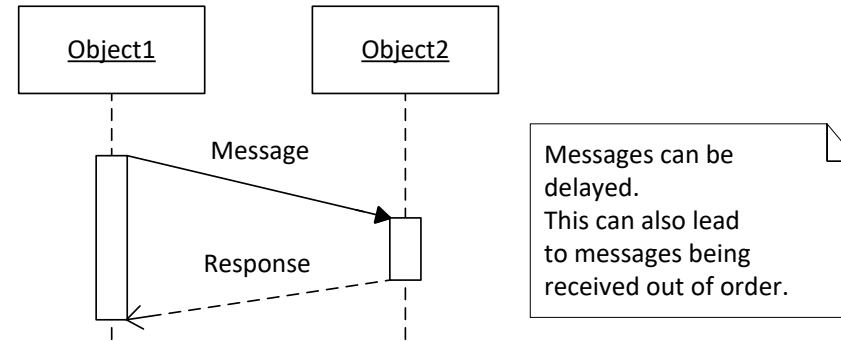

Messages can be delayed. This can also lead to messages being received out of order.

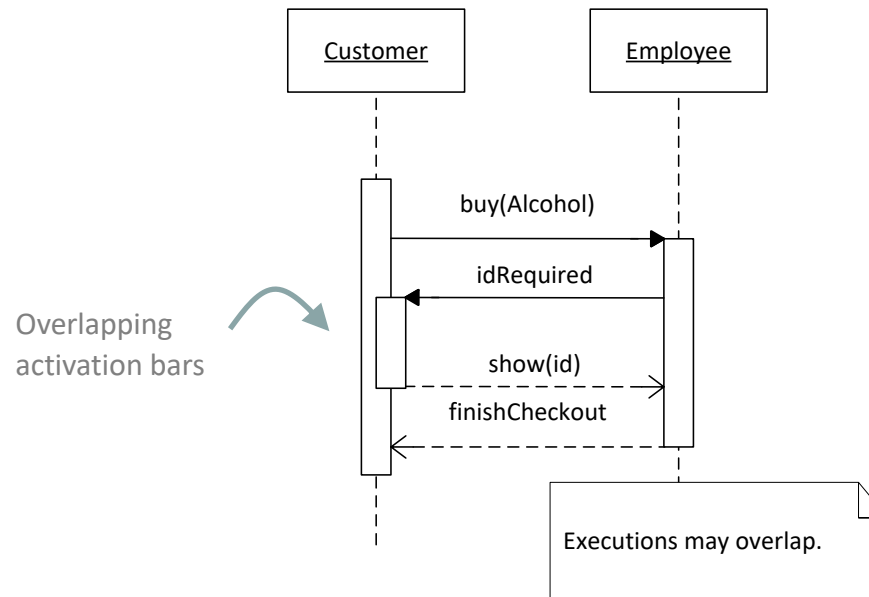

Overlapping activation bars

Executions may overlap.





QUIZ TIME!

Which of the following statements are true?

1. A Sequence Diagram can depict the interaction of a system with its surroundings.
2. The vertical axis is called interaction axis.
3. With asynchronous communication the sender does wait for an answer from the receiver.
4. Within Sequence Diagrams time is no separate dimension.

Quiz Time cont.

Which traces are possible for the given Sequence Diagram?

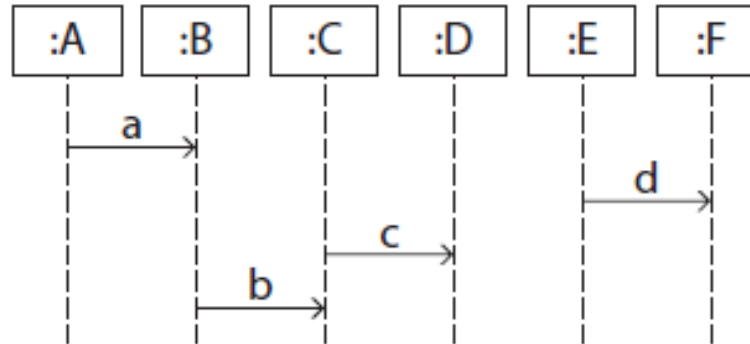

- 5. $d \rightarrow c \rightarrow b \rightarrow a$
- 6. $d \rightarrow a \rightarrow b \rightarrow c$
- 7. $d \rightarrow a \rightarrow c \rightarrow b$
- 8. $a \rightarrow d \rightarrow c \rightarrow b$



Quiz Time cont.

Which traces are possible for the given Sequence Diagram?

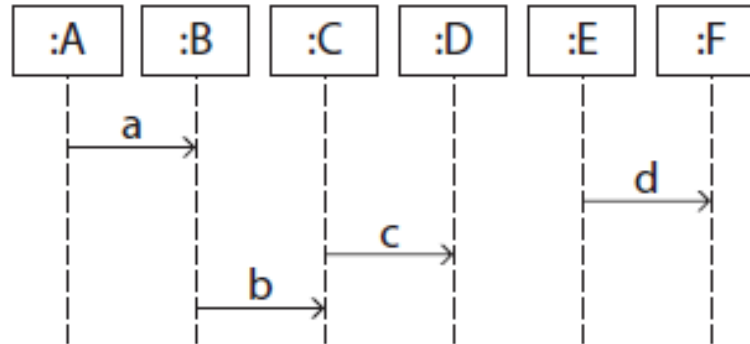

5. $d \rightarrow c \rightarrow b \rightarrow a$ ❌

6. $d \rightarrow a \rightarrow b \rightarrow c$ ❌

7. $d \rightarrow a \rightarrow c \rightarrow b$ ✅

8. $a \rightarrow d \rightarrow c \rightarrow b$ ✅



Activity Diagram

- Models execution and **behavior / workflow of a system**, not its structure
- Widely applicable to any kind of process modeling
- An activity is described by the actions and objects involved and the flow between them, not the components and their communications

- **Elements of activity diagrams**

- Activity
- Actions
- Control or object flows
- Decisions and Merges
- Forks and joins
- Start and end node
- Partitions

...

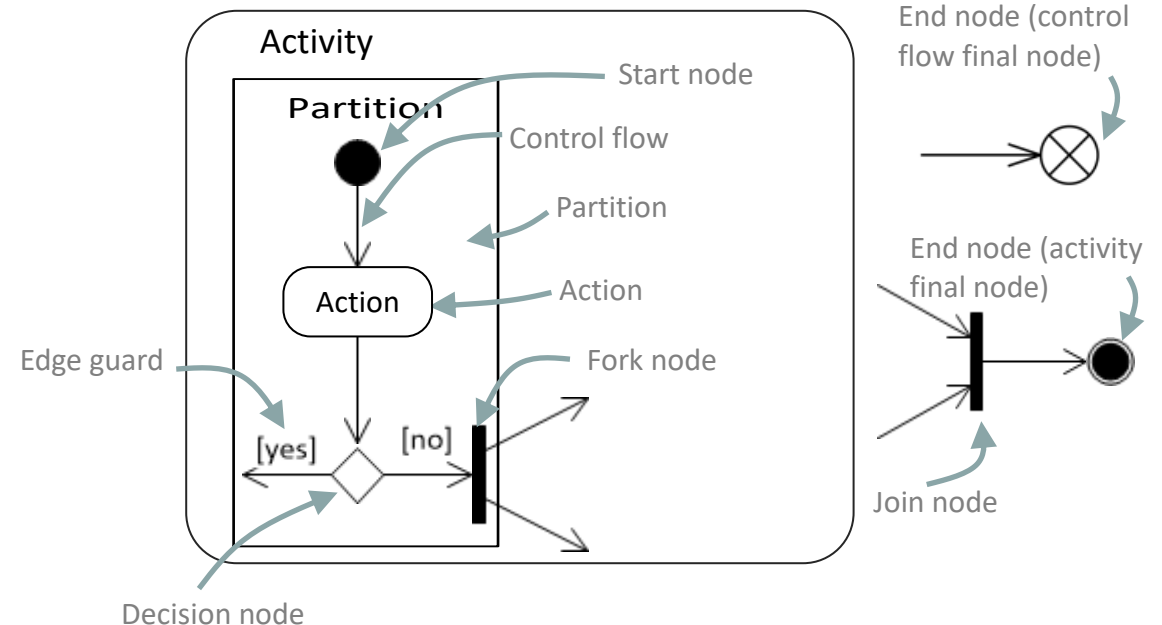

Activity Diagram: Activities, Actions and Transitions

- An activity is a sequence of actions and displayed using round-cornered rectangles that contain all elements of the activity
- An action is a single step within an activity and displayed using round-cornered rectangles

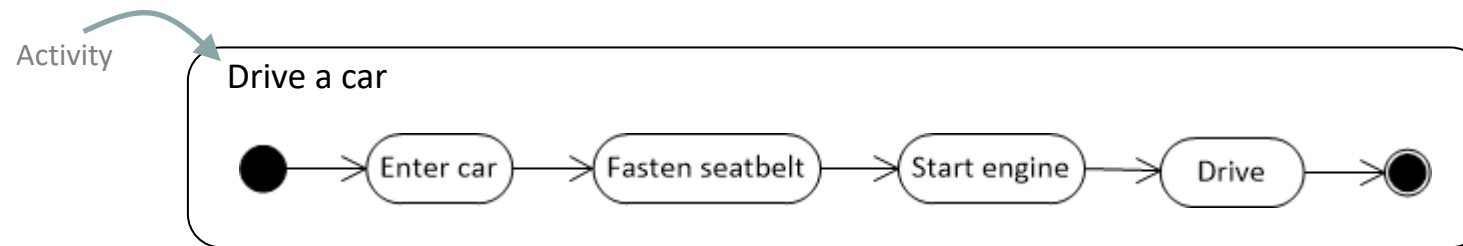

- Edges can have names and/or *guards*
 - A guard is a condition evaluated at runtime to determine if the edge can be traversed
 - Always put guards at decision nodes

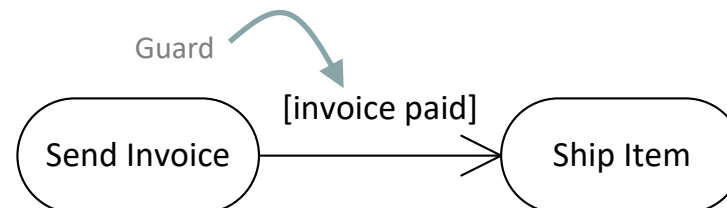

Activity Diagram: Object Nodes and Object States

- Object nodes are used to model the flow of objects
- Activity edges

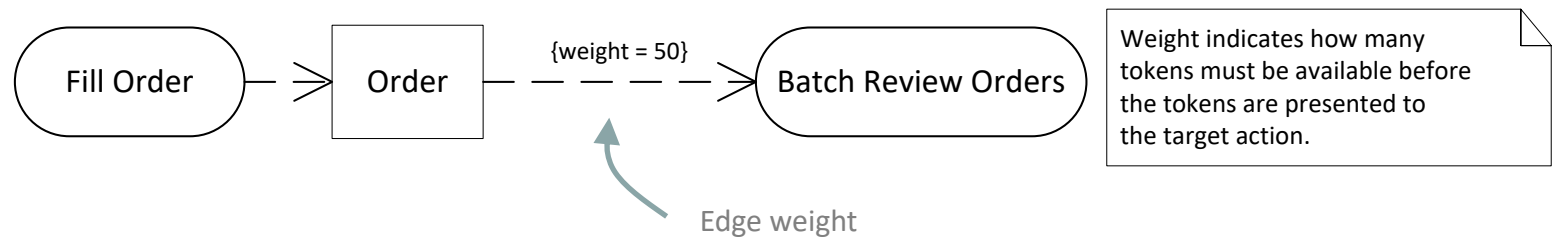
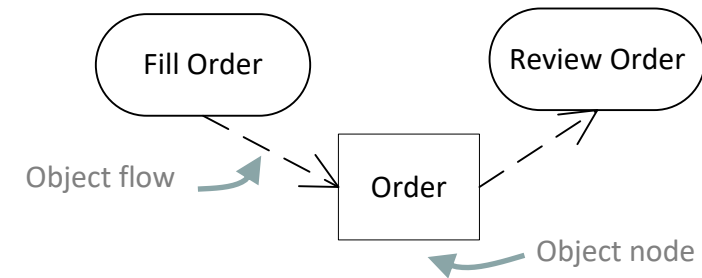

- Object states can be indicated by adding qualifiers to object nodes

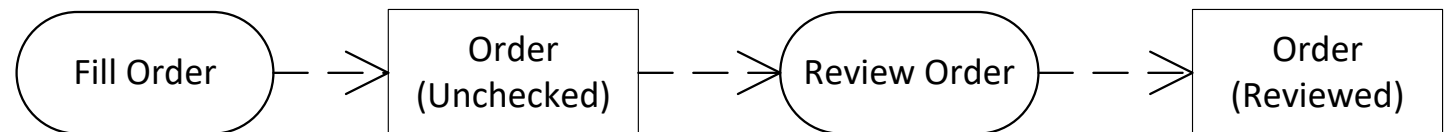

Activity Diagram: Object Decision Nodes

- Can divert and merge the flow
 - Only one outgoing edge can be traversed by each control token
- Guards at the branches define how the flow continues
 - Only one guard should evaluate to true to avoid race conditions
- Merging does not synchronize multiple concurrent flows

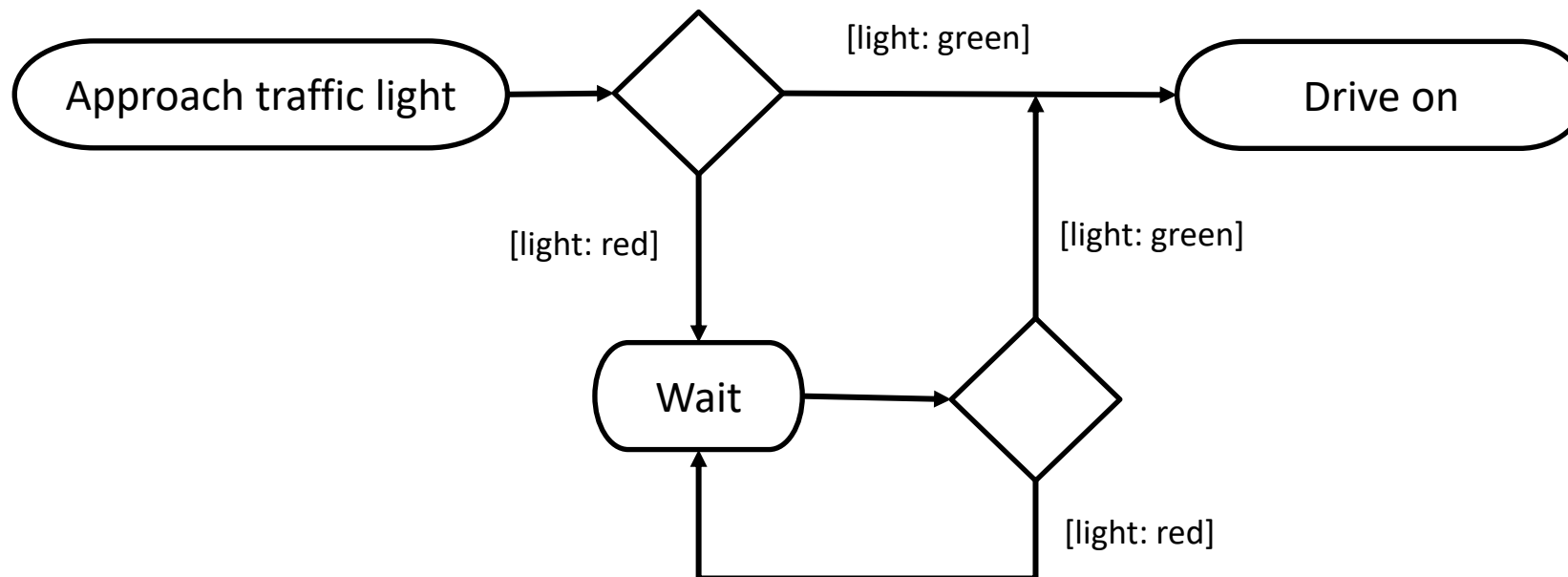

Activity Diagram: Forks and Joins

- Forks divide the flow unconditionally into multiple concurrent flows
- Joins synchronize multiple flows and continue once all flows are merged
- Joins can be conditional

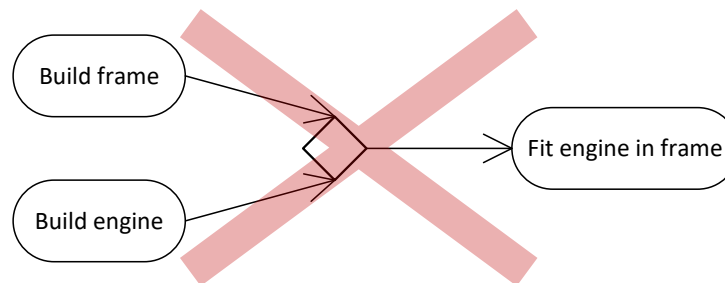
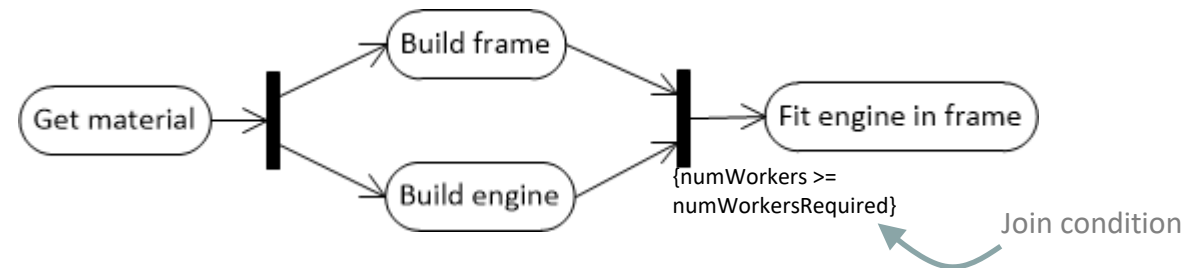

Activity Diagram: Exception Handler

- Especially important when describing the workflow of a software system
- An exception is an error that occurs during the execution of an action
- An exception handler protects an action from a specific type of exception by catching the exception
- If not caught, exceptions propagate

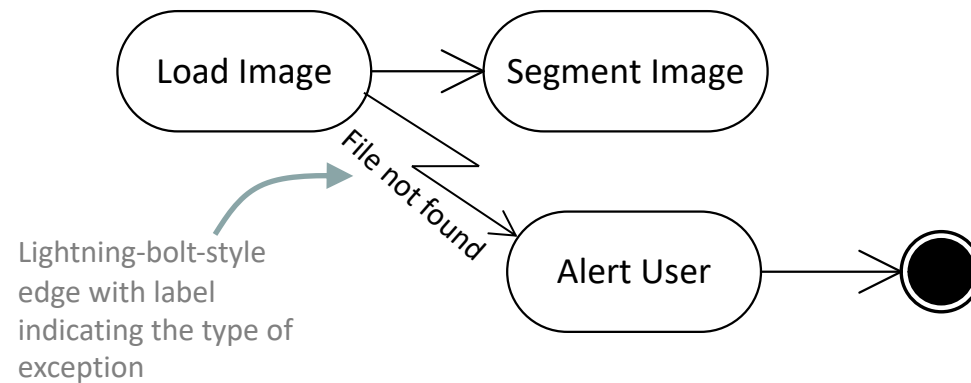

Partitions

- Partitions are a grouping mechanism
- They can be used to visualize responsibilities

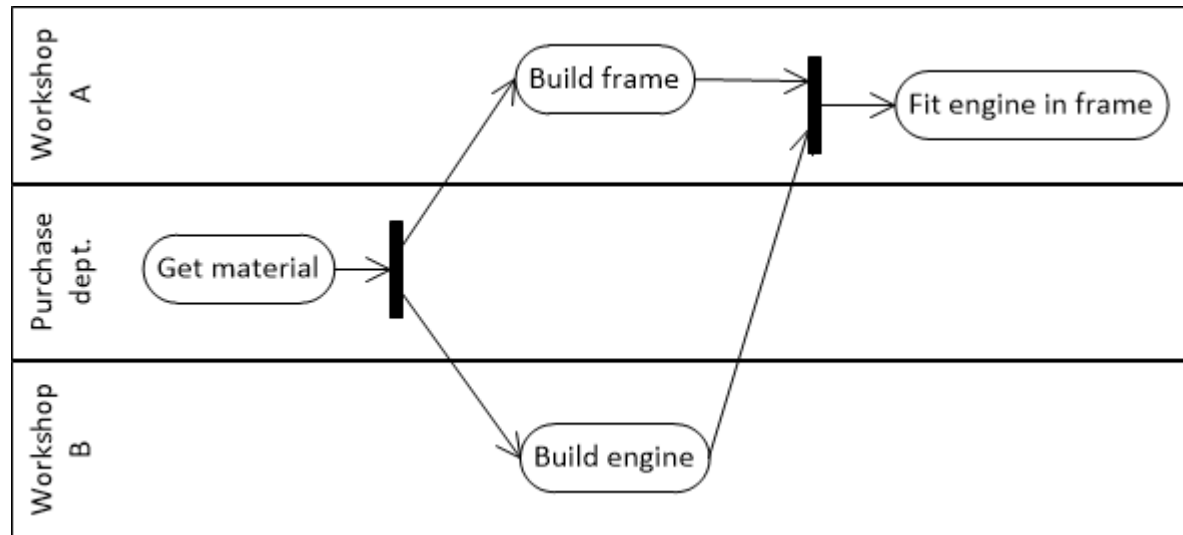



QUIZ TIME!

1. Can there be more than one activity final node in an Activity Diagram?
2. Which of the following nodes are elements of an Activity Diagram?
 - a) distribution node
 - b) fork node
 - c) decision node
 - d) communication node
 - e) join node





QUIZ TIME!

1. Can there be more than one activity final node in an Activity Diagram?
2. Which of the following nodes are elements of an Activity Diagram?
 - a) distribution node
 - b) fork node
 - c) decision node
 - d) communication node
 - e) join node
3. What is a fork node in an Activity Diagram?

There are many UML tools

- First iteration during initial design: By hand
- ArgoUML (<http://argouml.tigris.org>)
- Dia (<http://live.gnome.org/Dia>)
- Modelio (<http://www.modelio.org>)
- Microsoft Visio (available for students through www.studisoft.de)
 - Be sure to check out supplementary UML stencils: <http://www.softwarestencils.com/uml/index.html>
- MySQL Workbench
- yED (http://www.yworks.com/en/products_yed_about.html)
- IDEs like Visual Studio, Eclipse and NetBeans often offer UML functionality (directly or through plugins)
- Actually there are hundreds of tools available – a good start is on wiki:
http://en.wikipedia.org/wiki/List_of_UML_tools



Summary

- UML is a visual modeling language that eases communication about legacy as well as new (software) systems
 - Use it for the requirements analysis and for designing your implementation
- **Class and component** diagrams are structural diagrams
 - Start designing your implementation by drawing a component diagram
 - Afterwards, and in case you are using OOP, draw a more detailed class diagram
- **Use case** diagrams are behavioral diagrams that show the functionality your system provides on a high level
 - Use them while defining the functionality of your software project
 - Use them to quickly communicate what your system is capable of (e.g. here in class)

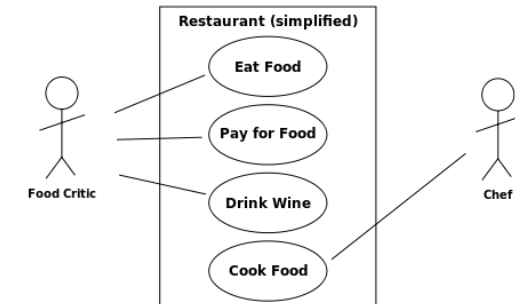
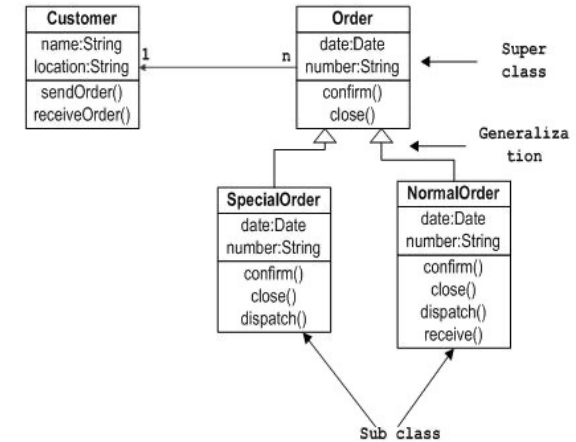

Nota Bene

We do expect you to show us (at least) one **UML diagram of your choice** in the kick-off and intermediate presentation!

- Usually recommended* for **kick-off**: Use Case Diagram "What functionality should my application offer? Who are the actors?"
- Usually recommended* for **intermediate**: Class Diagram or Sequence Diagram for more detailed visualization for your design choices
- Do not mix the UML diagram types and stick to the rules

* Of course this is heavily depending on your individual project and application.



Nota Bene

Identify ideas and resources that are not your own!

TUM [Citation Guide](#) and Informatics [Code of Conduct for Students](#)

If you are unsure about copyright or whether you can use a software library, github repository etc.,

... read the copyright notice or license!

... ask your supervisor or the course tutors!

